

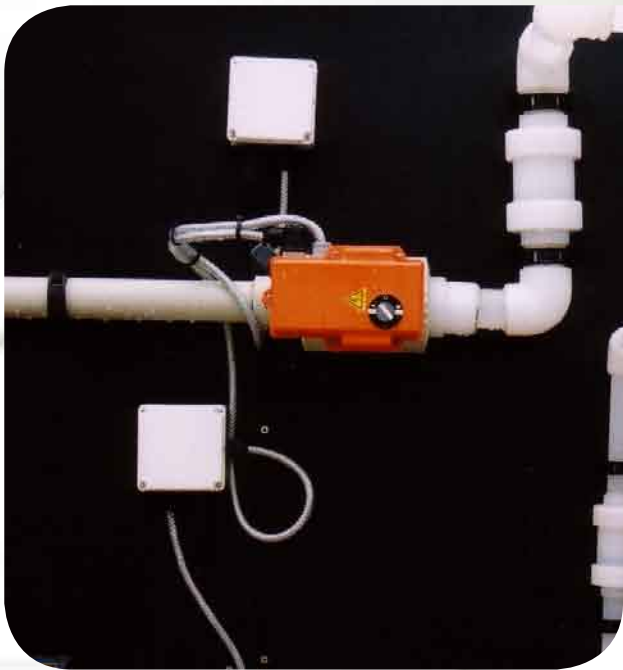

SYGEF®
PVDF Pipe, Fittings,
Hand Operated
Valves & Accessories

Product Catalogue



Technical Information

For technical data including operating & control pressures, dimensions as well as the use of accessories, please refer to data sheets which are available in both printed and electronic (pdf) formats from the Coventry Sales Office (details on back cover).

For details of our range of plastics pipe, fittings and hand operated valves in PVC-U, PVC-C, ABS, PP, PE as well as our INSTAFLEX PB range, please request Price Lists from the Coventry Sales Office.

Important Note

The technical data given in this catalogue is for preliminary information purposes only and is published without guarantee. All pictures and drawings are for illustrative purposes only and should not be regarded as wholly accurate in every detail. We reserve the right to withdraw or to alter the specification of any product without notice. Please consult our General Conditions of Supply.

Product Range PVDF 2007

	Page
Materials used for industrial pipe work	2
Design of industrial piping systems	4
Processing and installations	6
Jointing technology	15
SYGEF® Standard	29
SYGEF® Plus	105
SYGEF® Exhaust	133
SYGEF Exhaust Accessories	143
System Orientated Fusion Machines	159
Code Index	175
Sales Condition	189

Materials used for industrial pipe work

The material polyvinylidene fluoride (PVDF)

General

Polyvinylidene fluoride (PVDF) is a semi-crystalline thermoplastic having outstanding mechanical, physical and chemical properties. These result from the chemical structure of PVDF. Polyvinylidene fluoride belongs to the class of fluorinated polymers, whose best-known representative is polytetrafluoroethylene (PTFE, trade name: Teflon®). PTFE is characterised by a superb heat resistance and the best chemical resistance of all polymers; a great disadvantage is that it is not melt processable - e. g. into fittings. PVDF, on the other hand, combines various advantages of PTFE with good workability into structural parts. The fluorine content in PVDF amounts to 59 % by weight.

PVDF from GF is characterised by a very good mechanical behaviour and high temperature resistance. Because of the exceptionally wide pressure / temperature range in which PVDF can be used, it has opened, in connection with the specific characteristics of this material, completely new areas of application in plastic piping fabrication. These include applications in the semi-conductor, chemical and pharmaceutical industry, electroplating, paper and cellulose processing, the automotive industry and water treatment.

Pipes, fittings and valves of PVDF are uncoloured and opaque (milky, translucent).

By avoiding the addition of any additives, the outstanding characteristics of the material remain to the fullest extent, especially concerning the chemical resistance and physiological harmlessness.

Some of the advantages of PVDF:

- outstanding mechanical properties, even at high temperatures
- excellent chemical resistance
- no electrochemical corrosion
- long service life, even under intensely corrosive conditions
- outstanding resistance against UV and ³-radiation
- very pure material by implementing without additives
- no support of microbial growth
- physiologically harmless
- secure jointing by high-quality welding technology
- smooth inner surface
- very low heat conductivity
- excellent flame retardant properties

PVDF properties (reference values)

Characteristics	Value	Units	Test Standard
Density	1.78	g/cm ³	EN ISO 1183
Yield stress at 23 °C	> 51	N/mm ²	EN ISO 527-1
Tensile e-modulus at 23 °C	> 1800	N/mm ²	EN ISO 527-1
Charpy notched impact strength at 23 °C	>	9 kJ/m ²	EN ISO 179-1
Charpy notched impact strength at 0 °C	>	8 kJ/m ²	EN ISO 179-1
Ball indentation hardness (358N)	> 115	MPa	EN ISO 2039
Heat distortion temperature HDT A 1.80 MPa	> 113	°C	EN ISO 75-2
Crystallite melting point	173	°C	DIN 51007
Thermal expansion coefficient	0.12 ... 0.18	mm/m K	DIN 53752
Heat conductivity at 23 °C	0.19	W/m K	DIN 52612-1
Water absorption at 23 °C/24h	under 0.04	%	EN ISO 62
Colour	opaque	-	-
Limiting oxygen index (LOI)	44	%	ISO 4589-1

High purity properties

Due to the excellent stability of the PVDF molecule, it is one of the very few materials that can be processed, welded and used under severe conditions without the use of additives (no pigments, thermostabilisers, processing aids or fillers are used in the GF piping grades). This makes it the material of choice for applications that demand a very high purity of the medium and have stringent requirements stipulating that the materials which come in contact with the medium do not leach contaminants.

The PVDF raw materials used by GF fulfil the most rigid requirements of the semiconductor and pharmaceutical

industry regarding high purity. In addition, products made of PVDF exhibit a very smooth surface. Leach out tests according to SEMI57 are done regularly for quality control.

For SYGEF®Plus products, only virgin raw material is used.

For details regarding the properties relevant for the market segments, Semicon and Life Science, please see our SYGEF®Plus specification:

www.piping.georgfischer.com

=> Marketsegments

Design of industrial piping systems

Application area of pipes and fittings

Pressure/temperature diagram for PVDF

The following pressure/temperature diagram for PVDF pipes and fittings is valid for a lifetime of 25 years.

The design factor of 2.0 (respectively 1.6) recommended by GF is incorporated.

It can be used for water or media resembling water, in other words, media which have no derating factor regarding the chemical resistance.

Remark: Please take into account the pressure/temperature diagrams for our valves. Because of the construction and/or sealing material used, differences are possible when compared with pipes and fittings. This information can be found in the planning fundamentals of the relevant types of valves.

Attention: This diagram can only be used for applications with liquids!

In case of long-term applications at continuous pressure with temperatures above 100 °C, please contact your GF

representative.

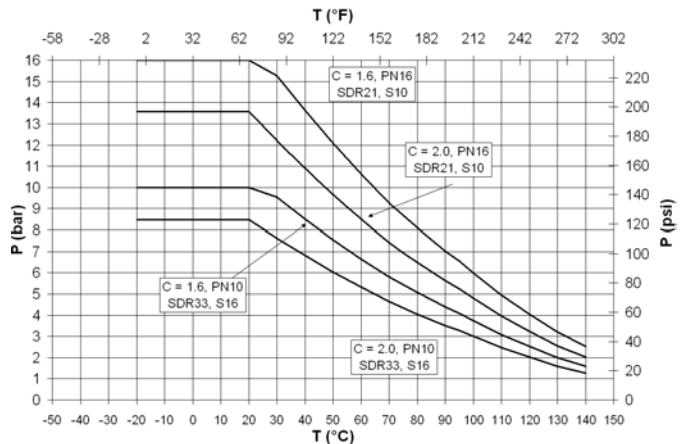

P Permissible pressure in bar, psi

T Temperature in °C, °F

Application example for the material PVDF

For continuously changing conditions of temperature or pressure the Miner's rule can be applied. The following example, an application in the pharmaceutical industry, show the calculation steps necessary:

Calculation basis:

Piping Series S10

Design factor: C = 2.0

Required operating lifetime 15 years

Main application:

Purified water (PW) at 25 °C and 5 bar pressure.

Steam Sterilisation:

Saturated steam at 135 °C and 2.2 bar pressure for 30 minutes daily.

The Miner's rule (calculation method for cumulative damage) is used for applications with varying conditions during their expected lifetime.

This takes into account the amount of time spent at each of the operating conditions:

$$T_x = \frac{100 \cdot T_1 \cdot T_2}{a_1 \cdot T_2 + a_2 \cdot T_1}$$

a1 a2 % of time spent at each condition

T1 T2 lifetime at the several operating conditions (pressure and temperature constant)

Tx calculated lifetime at intermittent load

for the above example the lifetimes are given as :

T₁ ≥ 50 years for the water

T₂ = 4471 hrs for the steam

The % of time spent at each condition is :

a₁ = 97.9 %

a₂ = 2.1 %

from the equation :

T_x = 214608 hrs = 24.5 years

It can be seen that this is higher than the specified operating lifetime and is therefore acceptable.

Design of industrial piping systems

Application area of valves

The engineering design of valves supplied by GF is based on the following design standards:

- EN ISO 16135: Industrial valves - Ball valves of thermoplastic materials
- EN ISO 16136: Industrial valves - Butterfly valves of thermoplastic materials
- EN ISO 16137: Industrial valves - Check valves of thermoplastic materials
- EN ISO 16138: Industrial valves - Diaphragm valves of thermoplastic materials
- EN ISO 16139: Industrial valves - Gate valves for thermoplastic materials
- EN ISO 21787: Industrial valves - Globe valves of thermoplastic materials

The valves easily comply with the requirements set out in the above standards. In many cases, they exceed the requirements most notably for pressure / temperature /

load capacity.

It should be noted that depending on the engineering design, at high temperatures there may be a reduction in the application limits of pipes and fittings, whether this be in the amount of the permitted pressure or the maximum temperature.

The technical data concerning

- pressure temperature diagram
- pressure loss
- flow characteristics
- k_v values
- average values for screw fastenings
- mounting and maintenance
- electric or pneumatic actuators

are to be found under the planning fundamentals of the respective valves.

Processing and installations

Change in length and flexible sections

General

Thermoplastics are subject to greater thermal expansion and contraction than metals. Pipes installed above ground, against walls or in ducts, especially those exposed to temperature variations, require changes in length to be taken up in order to prevent extra strain on the pipes. Length changes can be taken up by:

- a) flexible sections
- b) compensators

Flexible sections are the most common solution, being the simplest and the most economical. The calculations for and the positioning of flexible sections are therefore described in detail.

Fundamentals

The low modulus of elasticity of thermoplastics allows changes in length to be taken up by special pipe sections, where pipe supports are positioned so that they can take advantage of the natural flexibility of the material. The length of such sections is determined by the diameter of the pipeline and the extent of the thermal expansion to be compensated. In order to simplify design and installation, the temperature of the pipe wall, a third factor, will not be taken into account, especially since most pipes are installed in an environment with ambient temperature in the range of 5-25 °C.

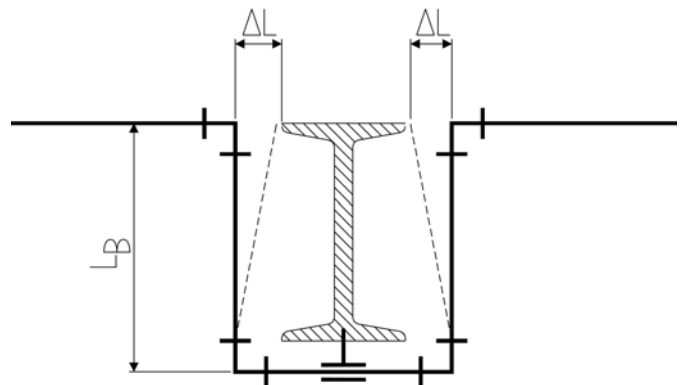
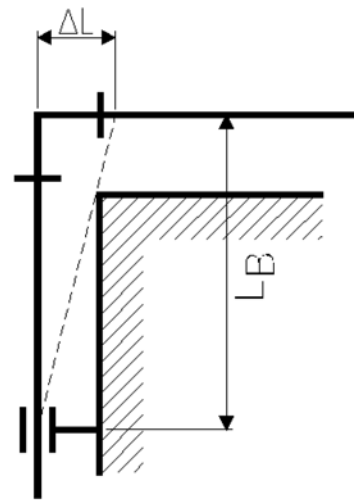
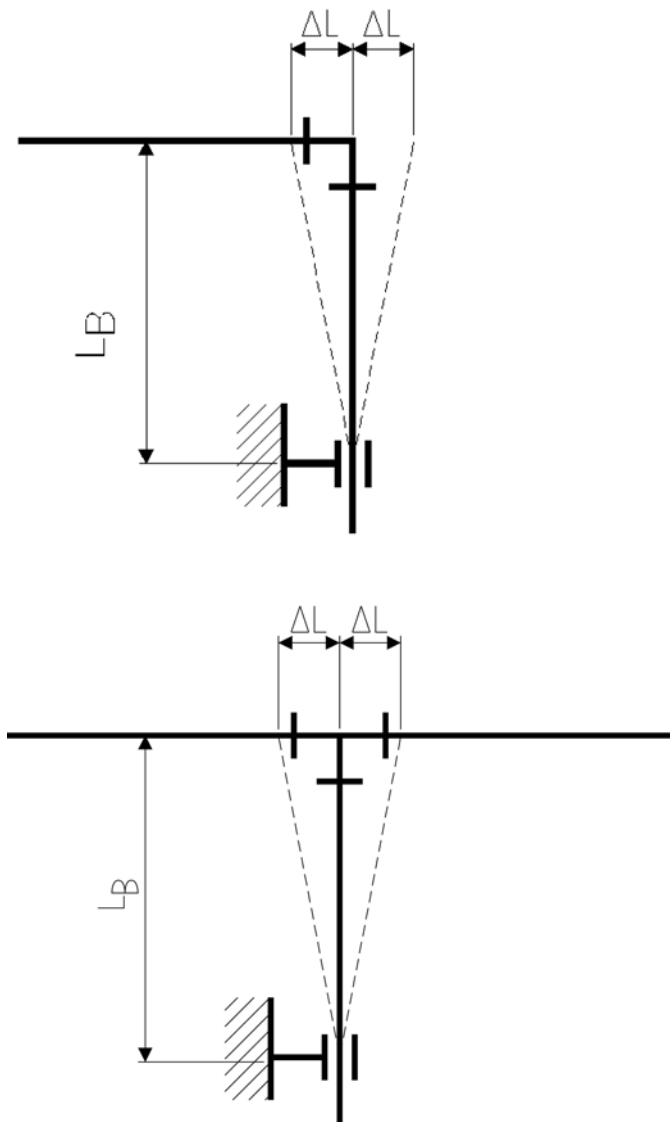

Flexible sections arise naturally at any branching or change in direction of the pipeline. The movement H of the flexible section as a result of a change ΔL in the length must not be restrained by fixed pipe brackets, protrusions wall, girders or the like.

Calculation of change in length and flexible sections

The **change in length caused by temperature** can be calculated using the following formula:

$$\Delta L = L \cdot \Delta T \cdot \alpha$$

with:

- ΔL = temperature-related change in length (mm)
- L = length of the pipe section (m)
- ΔT = difference of temperature (K)
- α = coefficient of linear expansion (mm / m K)

Some coefficients of linear expansion of polymers:

Material	$\alpha = \text{mm/m} \cdot \text{K}$
ABS	0.10
PA	0.10
PE	0.15 - 0.20
PP	0.16 - 0.18
PPS	0.15
PVC-U	0.07 - 0.08
PVC-C	0.06 - 0.07
PVDF	0.12 - 0.18

Important: If the operating temperature is higher than

Calculating the length of the flexible section

The required length of the flexible section can be calculated using the following formula:

$$L_B = \sqrt{\frac{3 \cdot d_a \cdot \Delta L \cdot E_{cm}}{\sigma_b}}$$

Boundary conditions for using the diagram

For easy determination of the required length of flexible section please use the following diagram. Please take into account the given boundary conditions.

- Assembly temperature $T_m = 20 \text{ }^\circ\text{C}$

the installation temperature, then the pipe expands. If, on the other hand, the operating temperature is lower than the installation temperature, then the pipe contracts in length.

The installation temperature must therefore be incorporated into the calculations as well as the **maximum** and **minimum** operating temperatures.

1. Pipe at installation temperature
2. Operating temperature above installation temperature
3. Operating temperature below installation temperature

Important:

- It is preferable to use + to indicate expansion of the pipe and - to indicate contraction.
- The larger change in length is the one to be used for determining the required length of the flexible section.



with:

- d_a = pipe outside diameter (mm)
- ΔL = change in length (mm)
- E_{cm} = average bending creep modulus for $t = 25 \text{ a}$ (N/mm^2)
- σ_b = permitted bending stress for $t = 25 \text{ a}$ (N/mm^2)

- T_b Operating temperature
- $\Delta T = T_b - T_m$
- allowable bending stress 15 % of σ_v
- PN 6 .. 16

Diagram for determining flexible sections of PVDF pipelines

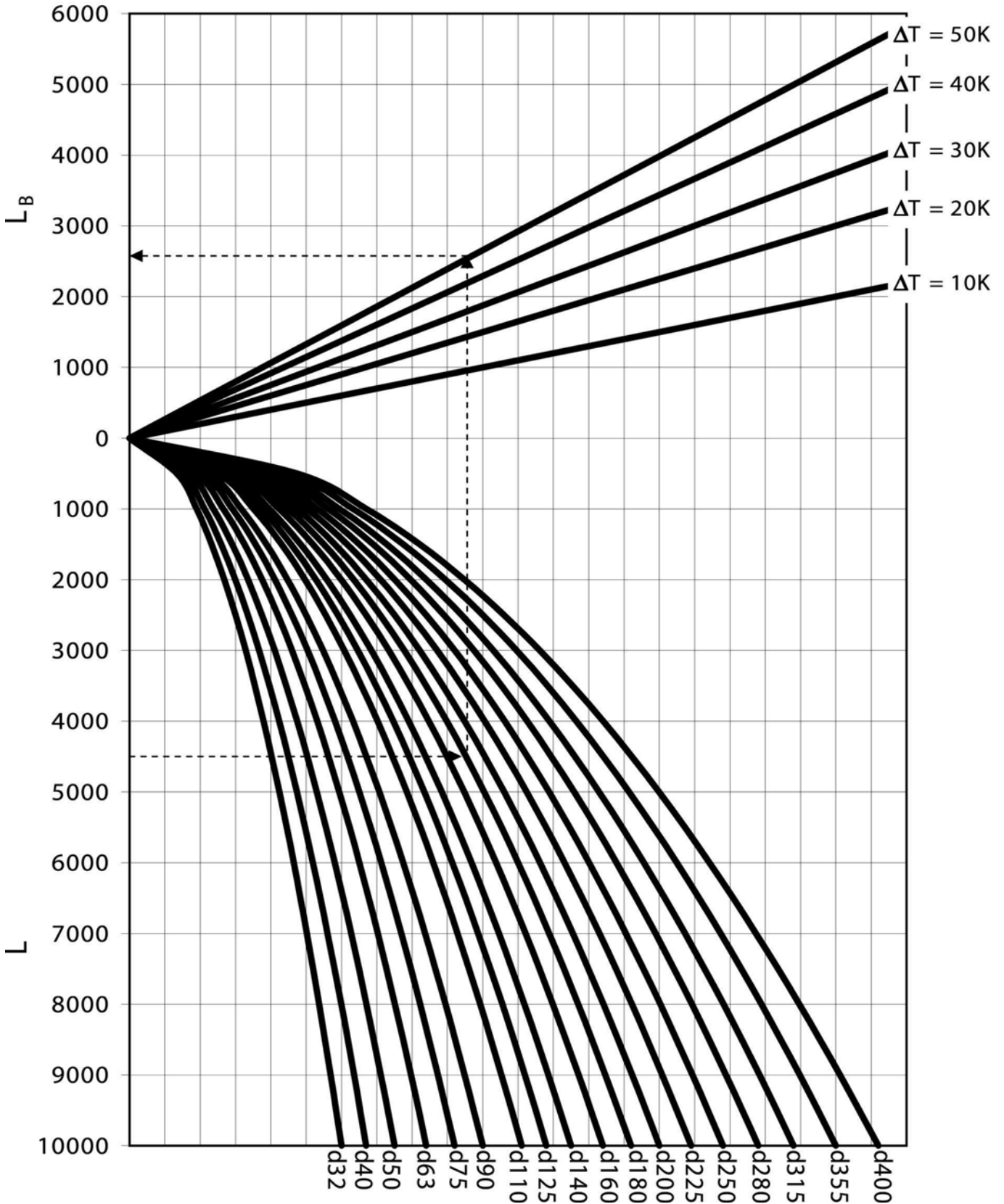

L Length of the pipe section in mm
 L_B Required length of flexible section in mm

Example: Determining the required flexible section

Calculating the relevant change in length

The example of an ABS process pipe serves to illustrate the procedure:

Length of piping from the fixed point to the branch point where the change in length is to be taken up: $L = 8 \text{ m}$.

Installation temperature: $T_m = 20 \text{ }^\circ\text{C}$

Max. working temperature: $T_1 = 35 \text{ }^\circ\text{C}$

Min. working temperature: $T_2 = -20 \text{ }^\circ\text{C}$

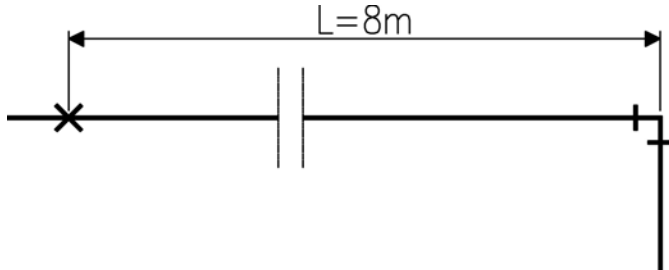

Expansion of the section during heating
 $+\Delta L_1 = L \cdot \Delta T_1 \cdot \alpha = 8 \cdot 15 \cdot 0.10 = 12 \text{ mm}$

Contraction during cooling
 $-\Delta L_2 = L \cdot \Delta T_2 \cdot \alpha = 8 \cdot 40 \cdot 0.10 = 32 \text{ mm}$

Temperature differences

$$\Delta T_1 = T_1 - T_m = 15 \text{ }^\circ\text{C}$$

$$\Delta T_2 = T_2 - T_m = -40 \text{ }^\circ\text{C}$$

Maximum change in temperature chosen
 $\Delta T = 40 \text{ }^\circ\text{C}$

Determining the length of the flexible section for ABS

The values needed to determine the necessary length are:

The maximum change in temperature from the 0-position (i. e. from the position in which the pipe was installed). But remember that the pipe could just as well contract as expand.

The pipe diameter d .

The length of the pipe section L .

With these values the required length of the flexible section can be read off from the diagram for ABS.

Continuing with the example introduced before and supposing that an ABS pipe with $d = 50 \text{ mm}$ is installed, the maximum change in temperature being $\Delta T = 40 \text{ }^\circ\text{C}$, the required length of the flexible section is seen directly from the diagram to be $L_b = 1300 \text{ mm}$.

Processing and installations

Pipe bracket spacing and support of pipelines

Pipe bracket requirements

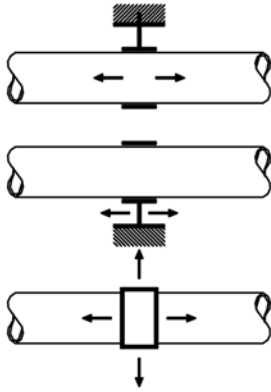

The inner diameter of the pipe bracket must exceed the outside diameter of the pipe in order not to interfere with the free movement of the pipe as a result of expansion or contraction. The inside edges of the pipe brackets must be such that the pipe surface cannot be damaged.

KLIP-IT pipe brackets

GF pipe brackets and clamps satisfy these requirements. These robust plastic pipe brackets can be used not only under rigorous operating conditions, but also where the pipework is subject to aggressive media or atmospheric conditions. They may be used for all materials of pipes.

Remark: Don't use KLIP-IT pipe brackets as fixed points!



d 16 to d 32



d 40 to d 160

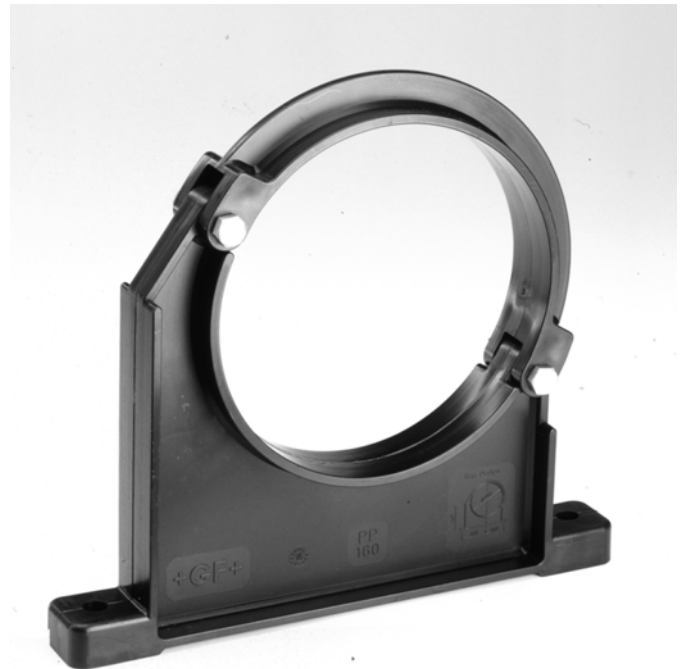

d 90 to d 400

Attention: Starting from the dimension d90 the KLIP-IT brackets must be installed standing, like shown in the assembly examples. The support distances given in the following, specified for the KLIP-IT tubing clamps, apply only to this mounting method.

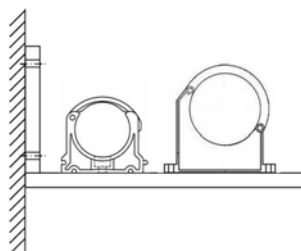

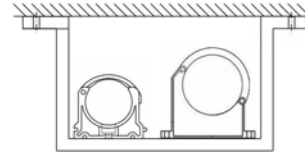
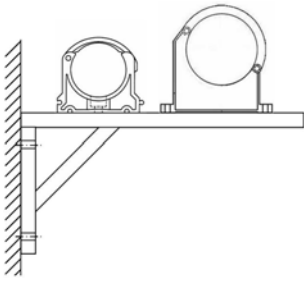

Arranging Loose Brackets

Axial movement of the pipeline must not be prevented by fittings placed next to pipe brackets or by any other component affecting the diameter of the pipe.

Sliding brackets and hanging brackets permit the pipe to move in different directions. Attaching a sliding block to

the base of the pipe bracket permits free movement of the pipe along a flat supporting surface. Sliding and hanging brackets are needed in situations where the pipeline changes direction and free movement of the pipe must be allowed.

Arranging fixed points

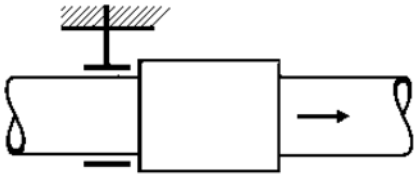

Placing a pipe bracket immediately adjacent to a fitting restricts movement due to changes in length to one direction (one-sided fixed point).

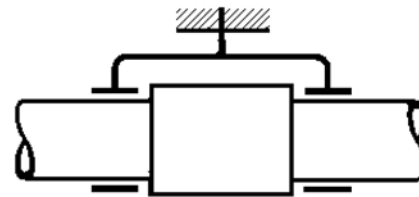
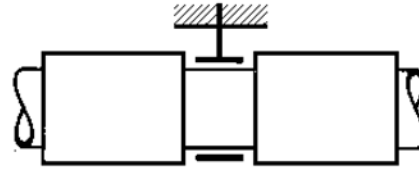

If, as is usually the case, it is necessary to allow changes in both directions, then the pipe bracket must be located between two fittings or a double bracket must be used.

Pipe brackets must be robust and mounted firmly to be able to take up the forces arising from changes in length in the pipeline. Hanging brackets or KLIP-IT pipe brackets are unsuitable for use as fixed points

Pipe brackets for cold insulation (MIP)

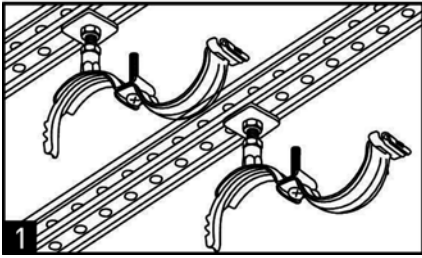

Open handle

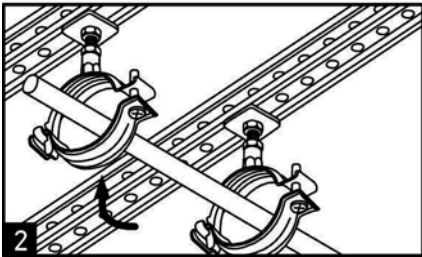

Insert pipe
Close handle with quick-action clamp

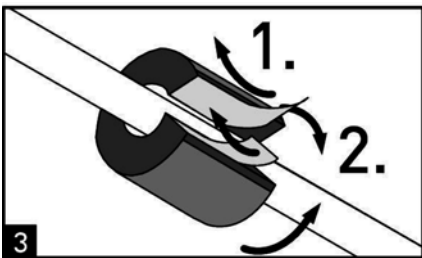

Assemble insulation
1. Take off foil
2. Press area of contact

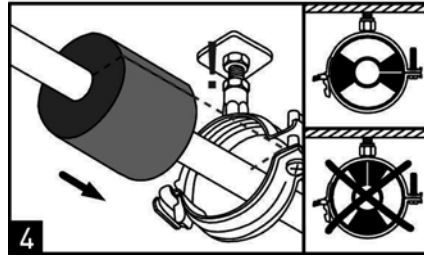

Move insulation into the bracket.
Attention! Make sure the insulator is positioned correctly.

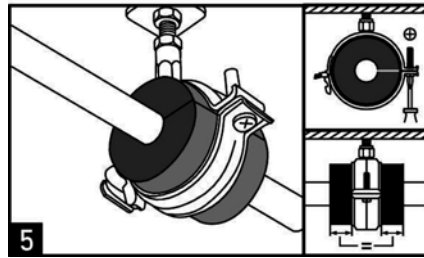

Tighten the screw

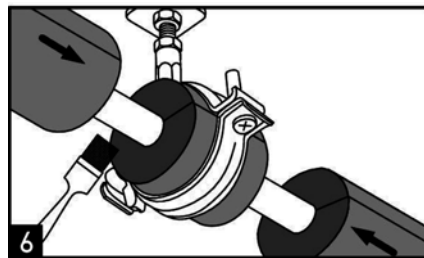

Coat areas of contact with adhesive and bond them

Using the tables for pipe bracket spacing

Plastic pipelines need to be supported at certain intervals depending on several factors: the material, the average pipe wall temperature, the density of the medium transported and the size and wall thickness of the pipe. Determining the spacing between pipe brackets is based on the permissible deflection of the pipe between consecutive brackets.

Caution!

The values given in the tables apply only to pipelines which are freely movable in the axial direction.

Pipelines which are fastened tightly in the axial direction (fixed installations) must be checked for buckling. In most cases, this leads to a reduction of the maximum inner pressure and shorter distances between the

support brackets. Furthermore, the forces that act on the fixed points must also be taken into consideration. For assistance, please contact your nearest GF representative.

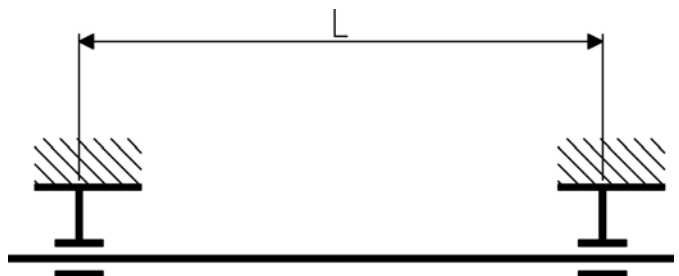

Pipe bracket spacing for PVDF for liquids with a density of 1 g/cm³

d mm	Pipe bracket spacing L for pipes SDR33 / S16 / PN10 and SDR21 / S10 / PN16 in mm at pipe wall temperature:									
	≤20 °C	30 °C	40 °C	50 °C	60 °C	70 °C	80 °C	100 °C	120 °C	140 °C
16	725	700	650	600	575	550	500	450	400	300
20	850	800	750	750	700	650	600	500	450	400
25	950	900	850	800	750	700	675	600	500	450
32	1100	1050	1000	950	900	850	800	700	600	500
40	1200	1150	1100	1050	1000	950	900	750	650	550
50	1400	1350	1300	1200	1150	1100	1000	900	750	600

d mm	Pipe bracket spacing L for pipes SDR21 / S10 / PN16 in mm at pipe wall temperature:									
	≤20 °C	30 °C	40 °C	50 °C	60 °C	70 °C	80 °C	100 °C	120 °C	140 °C
63	1400	1350	1300	1250	1200	1150	1100	950	800	650
75	1500	1450	1400	1350	1300	1250	1200	1050	850	700
90	1600	1550	1500	1450	1400	1350	1300	1100	950	850
110	1800	1750	1700	1650	1550	1500	1450	1250	1100	950
125	1900	1850	1800	1700	1650	1600	1500	1350	1200	1000
140	2000	1950	1900	1800	1750	1700	1600	1450	1250	1050
160	2150	2100	2050	1950	1850	1800	1700	1550	1350	1150
180	2300	2200	2150	2050	1950	1900	1800	1600	1400	1200
200	2400	2350	2250	2150	2100	2000	1900	1700	1500	1300
225	2550	2500	2400	2300	2200	2100	2000	1800	1600	1400
250	2650	2600	2500	2400	2300	2200	2100	1900	1700	1500
280	2850	2750	2650	2550	2450	2350	2250	2000	1800	1600
315	3000	2950	2850	2750	2600	2500	2400	2150	1900	1650
355	3200	3100	3000	2850	2750	2650	2500	2250	2000	1750
400	3400	3300	3200	3050	2950	2800	2650	2400	2100	1800

For other SDR the values should be multiplied by the following factors:

SDR21 / S10 / PN16 in the dimensional range d63 to d400 with 1.08

SDR17 / S8 / PN20 in the entire dimensional range with

1.12

Pipe bracket spacing for lines running vertically can be increased by 30 % with respect to the values in the table, i. e. table values multiplied by 1.3.

Pipe bracket spacing for PVDF for fluids of a density other than 1 g/cm³

If the liquid to be transported has a density not equal 1 g/cm³, then the bracket spacing in the table above should

be multiplied by the factor given in the following table.

Density of the fluid in g/cm ³	Factor for pipe bracket spacing
1.25	0.96
1.50	0.92
< 0.01	1.48 for SDR33 / S16 / PN10
	1.36 for SDR21 / S16 / PN16
	1.31 for SDR17 / S8 / PN20

Installing closely spaced pipe brackets: Carriers

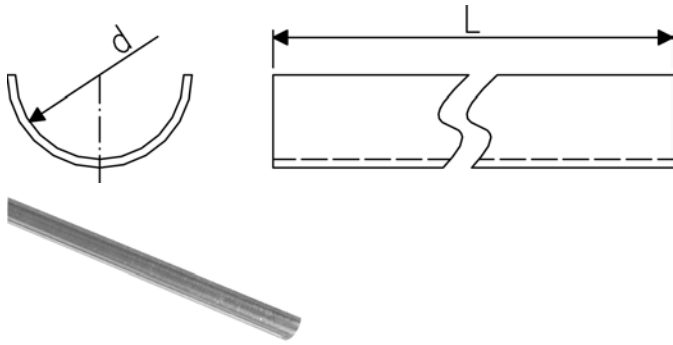

Continuous support may be more economical and practicable than pipe brackets for horizontal or vertical pipework, especially for small diameter pipes and in areas with high temperatures.

In order to avoid inadmissible loadings on the pipelines ensure during assembling an overlapping of the carriers in the pipe brackets.

The following table indicates the spacing distances when using carriers. These values apply regardless of the type of piping material or the temperature.

d mm	Spacing of supports when using carriers mm
16	1600
20	1750
25	1900
32	2000
40	2150
50	2300
63	2500
75	2600
90	2750
110	2900

Joining technology

Fusion jointing of PVDF

IR Plus® fusion jointing of PVDF piping systems

Fusion jointing method

In infrared (IR) fusion jointing the fusion areas of the components being joined (pipes, fittings, valves) are heated to fusion temperature without contact to the

heating element and jointed by means of mechanical pressure without using additional materials.

The principle of fusion jointing

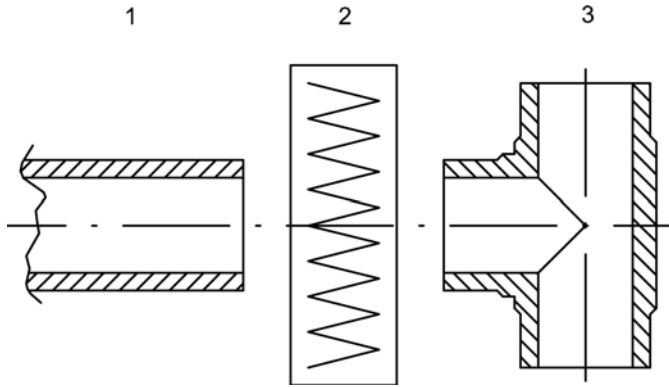

- 1 Pipe
- 2 Heating element
- 3 Fitting

The resulting fusion joints are homogeneous and display the following characteristics:

- non-contact heating of the jointing components eliminates the risk of contamination and inhomogenities;
- smaller jointing beads due to adjustment of jointing pressure path prior to the fusion process itself, i. e. elimination of the equalisation process;
- adjustment of the jointing pressure path also ensures excellent reproducibility of the fusion joints;
- low-stress fusion joints due to very uniform heating by means of IR radiation.

General requirements

The basic rule is that only similar materials can be fusion jointed. The components to be joined must have the

same wall thicknesses in the fusion area. Maximum permissible wall displacement: 10 %.

Only same wall thicknesses in the fusion area

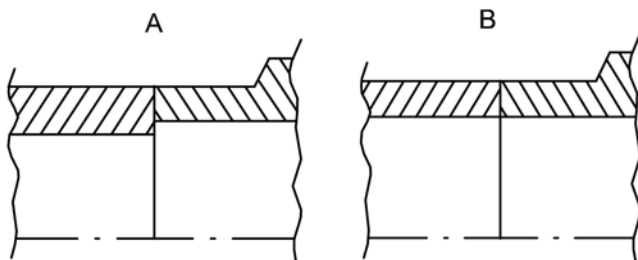

- A incorrect
- B correct

IR fusion jointing must only be performed by personnel trained in the use of this method. Training is provided world-wide by qualified GF IR Plus® welding instructors.

Tools required

Infrared fusion jointing requires a special jointing machine in addition to the tools normally used for plastic pipework construction (pipe cutters, etc.).

GF supplies three types of IR Plus® fusion jointing machines:

IR63 Plus®: for fusion joints in the size range d20-63 mm



IR225 Plus®: for fusion joints in the size range d63-225 mm



IR315 Plus®: for fusion joints in the size range d250-280-315 mm

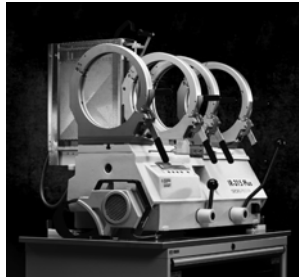

General conditions

Protect the area of the fusion joint from adverse weather conditions, such as rain, snow or wind. The permitted temperature range for IR Plus® fusion jointing is between +5 °C and +40 °C. Outside this range, suitable

action must be taken to ensure that these conditions are maintained. It must also be ensured that the components being joined are in this temperature range.

Preparing the fusion joint and operating the IR fusion jointing machine

In principle, IR fusion jointing machines do not require any special preparation, other than to ensure that all components being joined are clean.

Operation of the IR machines is defined exactly in the operating instructions, but we strongly recommend attending a 1-day training course to become a qualified IR welder.

Properties and characteristics of IR fusion joints

Non-contact heating

The components being joined are heated uniformly and without contact to the ideal fusion temperature by infrared radiation.

A defined gap between the heating element and the end faces minimises the risk of contamination of the jointing surface. Contamination of the heating element by plastic particles is thus also eliminated.

Reduced bead formation

The fusion bead produced during jointing is considerably reduced without any loss of quality. Bead-forming equalisation is eliminated by non-contact softening of the end faces. The minimal, defined bead is only formed during the jointing process. The fusion area thus has improved flow dynamics, low clearance volume and greater throughput area.

Reproducible jointing processes

The jointing path controls the jointing pressure and thus the fusion process. The high reproducibility of the joints is assured by the clearly defined and controlled process sequence.

Clear, simple operator guidance

Clear, unambiguous operator guidance via the liquid crystal display leads the user interactively through the fusion process in logical operating steps.

Welding report/traceability

The welding parameters for the relevant welding operations can be read out directly via various interfaces on the machine. It is possible to print these out on paper (commercially available printers), on labels or to employ electronic data output (PCMCIA card).

This automatically provides an accurate record with all the essential fusion parameters for each individual fusion joint.

Joining technology

Fusion joining of PVDF

BCF® Plus fusion joining of SYGEF® PVDF piping systems

Fusion joining method

The fusion joining process consists in transmitting precisely defined thermal energy to the pipe and fitting ends being joined by means of half-shell heating elements.

At the same time an elastic, pressurised bladder supports the inside surface of the fusion zone in order to prevent the formation of an internal fusion bead.

Holding the melted thermoplastic under controlled pressure ensures ideal, homogeneous fusion of the plastic components.

Fully automatic process control of the fusion joining process with a fusion joining machine developed in-house by GF permits very simple handling and reproducible fusion quality.

- 1 Pipe clamping element
- 2 Fitting
- 3 Heating element with fitting - clamping device
- 4 Pressurised bladder
- 5 Pipe
- 6 Compressor for bladder
- 7 Cooling air blower
- 8 Control unit control panel
- 9 Compressed air supply

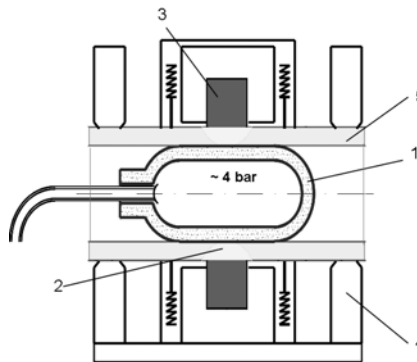

- 1 Pressurised bladder
- 2 Welding zone
- 3 Heating element
- 4 Clamping position
- 5 Pipe / Fitting

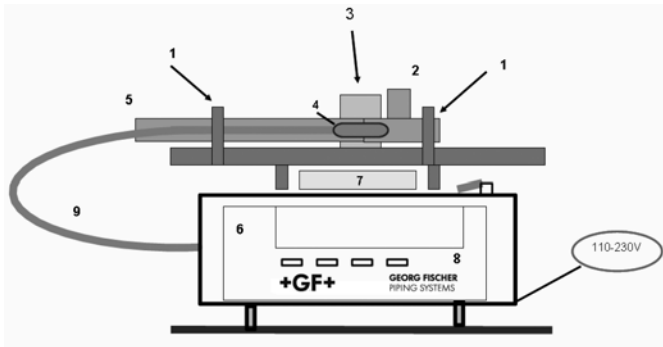

General requirements

SYGEF® fittings and SYGEF® pipes are suitable for working pressures up to 16 bar at 20 °C (water). SYGEF® diaphragm valves are designed for a

maximum working pressure of 10 bar at 20 °C (water). Refer to the chapter on pressure/temperature diagrams for details of permissible working pressures.

Tools required

BCF joining requires the SYGEF® HP BCF® joining machine in addition to the tools normally used for plastic pipework construction (pipe cutters, etc.).



Preparing the fusion joint and operating the BCF® Plus fusion jointing machine

In principle, BCF® Plus fusion jointing machines do not require any special preparation, other than to ensure that all components being joined are clean.

Operation of the BCF® Plus machines is defined exactly in the operating instructions, but we strongly recommend attending a 1-day training course to become a qualified BCF® welder.

Properties and characteristics of BCF® Plus fusion joints

Welding free from beads and crevices

The result of the jointing process is a surface similar to the actual pipeline components, free from beads or crevices. There are therefore no dead spaces, the surface roughness lies in the range Ra 0.25.

Reproducible jointing processes

The high reproducibility of the joints is assured by the clearly defined and controlled process sequence.

Clear, simple operator guidance

Clear, unambiguous operator guidance via the liquid

crystal display leads the user interactively through the fusion process in logical operating steps.

Welding report/traceability

The welding parameters for the relevant welding operations can be read out directly via various interfaces on the machine. It is possible to print these out on paper (commercially available printers), on labels or to employ electronic data output (PCMCIA card).

This automatically provides an accurate record with all essential fusion parameters for each individual fusion joint.

Joining technology

Fusion jointing of PVDF

Butt fusion jointing of PVDF piping systems

Butt fusion jointing method

The fusion areas of the pipes and fittings are heated to fusion temperature and joined by means of mechanical pressure, without using additional materials. A homogeneous joint results. Butt fusion must only be carried out with fusion jointing machines which allow the jointing pressure to be regulated. Details of the requirements for machines and equipment used for fusion jointing thermoplastics are contained in DVS 2208 Part 1. The drawing to the right illustrates the principle of fusion jointing.

The principle of fusion jointing

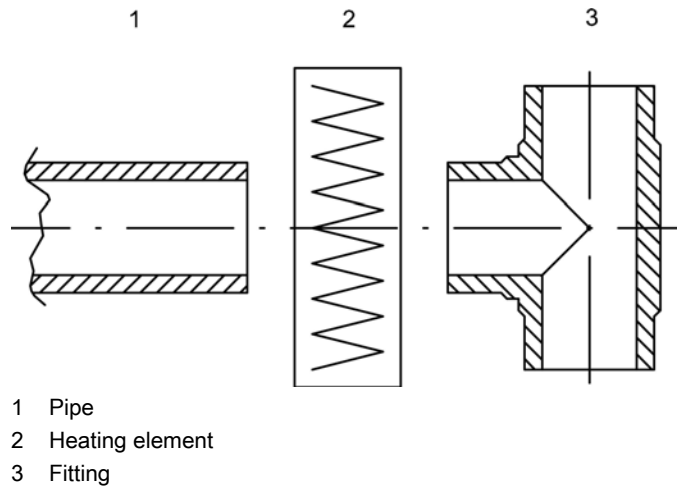

General requirements

The basic rule is that only similar materials can be fusion jointed. For best results, only components which have a density between 1.70 and 1.80 g/cm³ and a melt flow index in the range from MFR 230/5 1.0 to 25 g/10 min should be fusion jointed. This requirement is met by PVDF butt fusion fittings from GF.

The components to be joined must have the same wall thicknesses in the fusion area.

Join only components with similar wall thicknesses

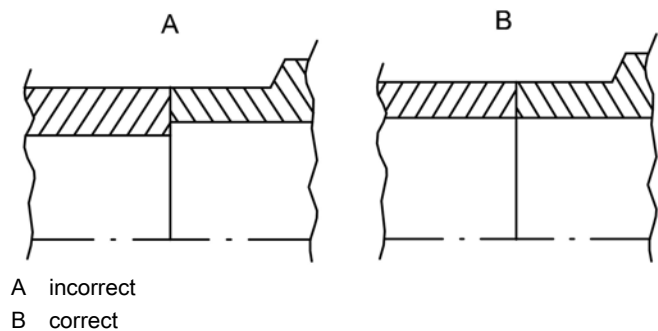

Heated tool butt fusion jointing may only be performed by adequately trained personnel.

Tools required

Butt fusion jointing requires a special jointing machine in addition to the tools normally used for plastic piping construction (pipe cutters, saw with cutting guide). The fusion jointing machine must meet the following minimum requirements:

The clamping equipment must hold the various parts securely without damaging the surfaces. Possible ovality can be largely compensated by centred clamping of the components to be joined. It must also be possible to hold all parts firmly in alignment.

The machine must also be capable of face planing the fusion surfaces of pipes and fittings.

The fusion jointing machine must be sufficiently solid to be able to absorb the pressures arising during the fusion procedure without detrimentally deforming the joint.

The heating surfaces of the heating element must be flat and parallel. The temperature variation over the working area must not exceed 10 °C. The machine should be set up and operated according to the manufacturer's instructions.

The fusion procedure detailed below including the preparation is based on DVS 2207-15 "Welding of thermoplastics - Heated tool welding of pipes, pipeline, components and sheets out of PVDF".

General conditions

Protect the area of the fusion joint from adverse weather conditions, such as rain, snow and wind. At temperatures below +5 °C or above +45 °C, measures must be taken to ensure that the temperature in the working area is in the range required for satisfactory jointing and does not hinder the necessary manual tasks.

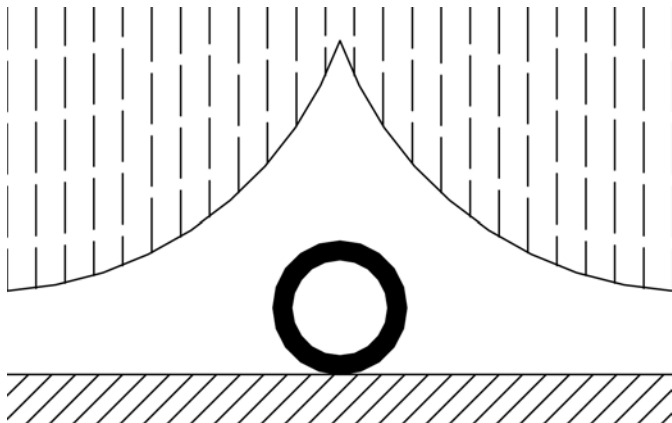

Protect the fusion area

Screening the fusion area can ensure a more even temperature distribution on the entire circumference of a pipe subject to direct sunlight. The pipe ends at the opposite end of the fusion areas should be sealed whenever possible to reduce to a minimum the cooling of the fusion surfaces which can be caused by wind.

Preparation of the fusion joint

The quality of the fusion process is governed by the care with which the preparatory work is carried out. This part of the procedure therefore deserves special attention.

Heating tool

Set the temperature of the heating element to 240 °C. Check the temperature. The fusion temperature should be between 232 °C and 248 °C.

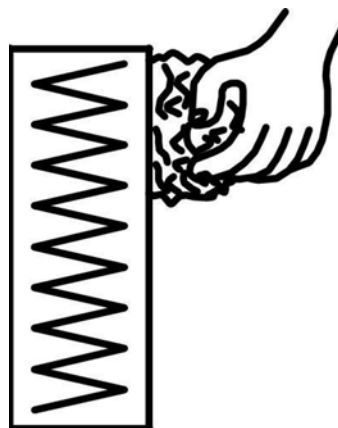
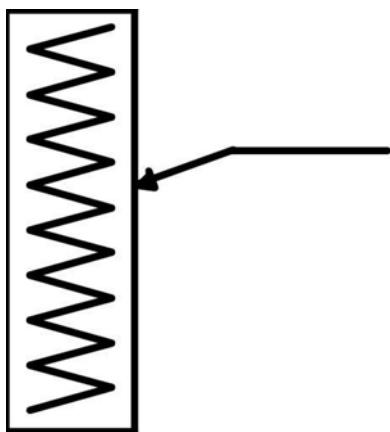

Check the temperature

Temperature of heating element 232 °C to 248 °C

To test the thermostat, check temperature before commencing the fusion jointing. This is best carried out with the help of a digital thermometer. But only thermometers with a sensor for measuring surface temperature are suitable.

To ensure it is being maintained at the correct level the fusion temperature should be checked from time to time during the jointing work. The temperature of the heating element is particularly sensitive to wind.

Clean the heating element

Clean the heating element with dry, clean paper before each fusion joint!

Protect the working surface of the heating element from becoming soiled. Clean both faces of the heating element with dry, lint-free paper before each fusion joint. Protect the heating element from wind, damage and soiling during the intervals between making fusion joints.

Planing and subsequent checking

Before machining the fusion surfaces, make sure that the tools and the work pieces are clean and grease-free even beyond the fusion zone; if necessary, clean with a cleaning fluid.

All the components clamped into the fusion jointing machine are planed simultaneously with the planer provided. The shavings should not be thicker than ≤ 0.2 mm. This step is completed when there is no unmachined area left on either of the parts to be joined. This is normally the case when no more shavings come

off the machined surface.

Remove any shavings which may have fallen into the pipe or fitting with e. g. a brush. The fusion surfaces should not be touched by hand under any circumstances. Otherwise they must be cleaned with cleaning fluid.

Once they have been machined, the parts are moved together until they touch. The gap between the two parts must not exceed 0.5 mm at any point.

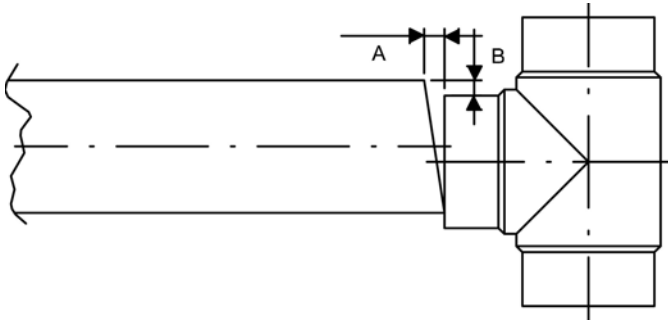

A max. gap: 0.5 mm

B max. displacement: 10 % of wall thickness

Check the wall alignment and gap

The alignment of the two parts should be checked at the same time. A possible misalignment on the outside must not exceed 10 % of the thickness of the wall. If this limit is exceeded, a better clamping position is to be sought, e. g. by rotating the pipe. In such a case, however, the surface must be re-planed.

Important: The fusion surfaces must be planed immediately prior to the jointing.

Setting the fusion pressure

Equalise and heat

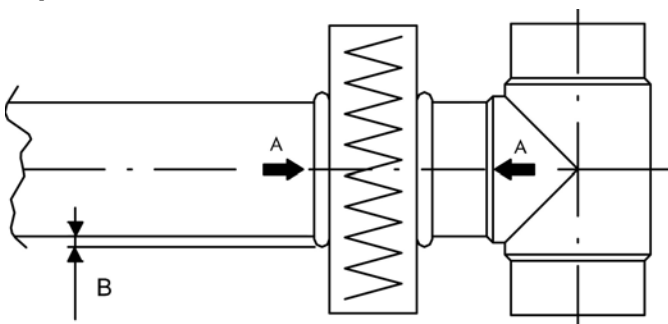

Fusion jointing requires different pressures to be applied during equalisation and jointing on the one hand and during the heat soak period on the other. Please see the following diagram.

Pressure/Time Diagram

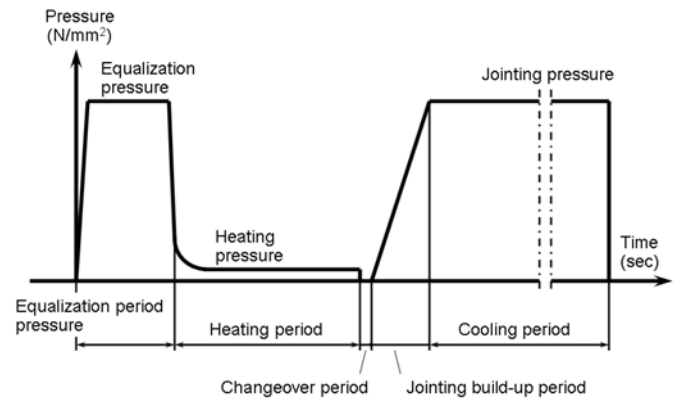

The specific jointing pressure required for equalisation and fusion can be found in the following table with the heating and cooling periods. The table lists the times for various wall thicknesses. Interpolate for intermediate values.

The force needed for equalisation and jointing (F_A) is given by the product of the fusion area and the specific jointing pressure ($F_A = A \cdot p$). The force (F_B) required to move the pipe must be added to this. ($F_{tot} = F_A + F_B$). This latter force includes the intrinsic resistance of the machine and the resistance of the axially mobile pipe or fitting clamped in it. The resistance of longer pipes should be reduced as far as possible by placing rollers beneath them. The kinetic force (F_B) should not exceed the jointing force (F_A).

A Contact force

B Height of bead (see tabulated values)

Approximate values for butt fusion of PVDF¹⁾

Wall thickness (mm)	Equalisation at p=0.10 N/mm ² Height of bead (mm)	Heating time ²⁾ p=0.01 N/mm ² (sec)	Changeover time max. (sec)	Time to reach full jointing (sec)	Cooling time ²⁾ under jointing p=0.10 N/mm ² (min)
1.9 .. 3.5	0.5	59 .. 75	3	3 .. 4	5 .. 6
3.5 .. 5.5	0.5	75 .. 95	3	4 .. 5	6 .. 8.5
5.5 .. 10.0	0.5 .. 1.0	95 .. 140	4	5 .. 7	8.5 .. 14
10.0 .. 15.0	1.0 .. 1.3	140 .. 190	4	7 .. 9	14 .. 19

15.0 .. 20.0	1.3 .. 1.7	190 .. 240	5	9 .. 11	19 .. 25
20.0 .. 25.0	1.7 .. 2.0	240 .. 290	5	11 .. 13	25 .. 32

1) in accordance with DVS 2207-15

2) The times are affected by the pipe wall thickness, the outside temperature and wind strength.

Determine the values to be set for equalisation and jointing on the basis of the information above, bearing in mind the instructions from the manufacturer of the fusion jointing machine before commencing the fusion process.

Fusion jointing procedure

Once it has attained the fusion temperature, position the heating element in the fusion jointing machine. Press the parts to be joined against the heating element with the force required for equalisation until the entire circumference of each of the jointing faces rests completely against it and a bead (see the table) has formed. Reduce the equalisation pressure almost to 0 (p ~ 0.01 N/mm²). The heating time listed in the table is measured from this moment.

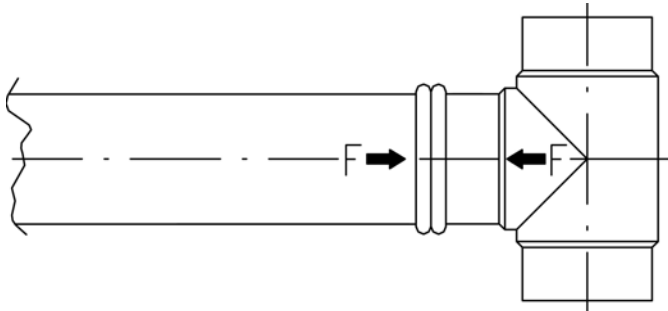

Join and cool

Leave parts in the fusion jointing machine at fusion pressure until the end of the cooling period!

Once the heating period has elapsed, remove the parts from the heating element which should then be removed without touching the jointing surfaces and push the parts together immediately. The changeover time must not

Carrying out the pressure test

All fusion joints must be allowed to cool completely before pressure testing, i. e. as a rule wait about 1 hour

exceed the value listed in the table. Pay particular attention during jointing that the parts be moved together swiftly until the surfaces are about to touch.

Then they should be moved together so that they are in contact along the entire circumference. Next the pressure should be increased rapidly to the present jointing pressure within the period of time specified in the table. This pressure must be maintained during the entire cooling period. Adjustment may be necessary, especially shortly after the jointing pressure has been attained.

The jointed parts must stay in the fusion jointing machine under jointing pressure until the end of the cooling period specified in the table.

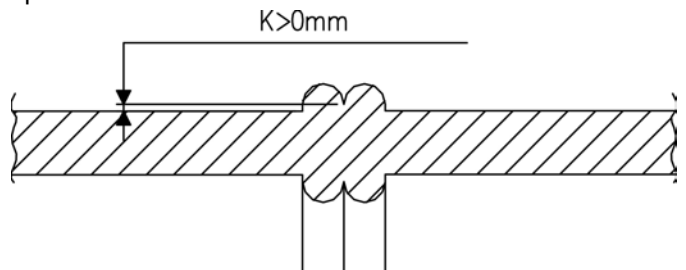

Fusion check

A bead should form around the entire circumference of the pipe. K in the diagram to the left should always be positive.

after the last joint has been completed.

Joining technology

Fusion joining of PVDF

Socket fusion joining of PVDF piping systems

Socket fusion joining method

In this form of fusion joining, which requires heating tools, the pipe end is inserted into the socket of the fitting; no additional material is used. The pipe end and fitting socket are heated to fusion temperature using a heating bush and a heating spigot, respectively, and are then pushed together.

Details of the requirements for machines and equipment used for fusion joining thermoplastics are contained in DVS 2208 Part 1.

The pipe end, fitting socket and heating tools correspond in such a way that the necessary joining pressure is attained during joining, resulting in a homogeneous joint.

Fusion joining procedure

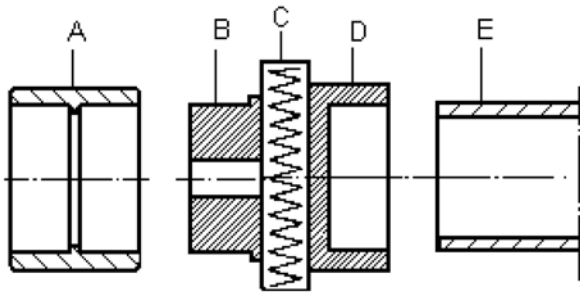

- A Fitting
- B Heating spigot
- C Heating element
- D Heating bush
- E Pipe

Heating

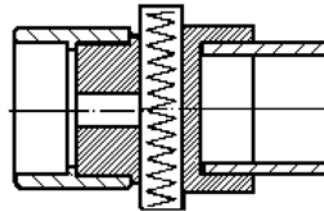

Finished joint

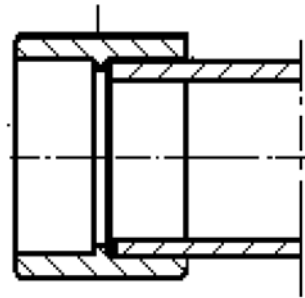

General requirements

The basic rule is that only similar materials can be fusion joined. For best results, only components which have a density between 1.70 and 1.80 g/cm³ and a melt flow index in the range from MFR 230/5 1.0 to 25 g/10 min should be fusion joined. This requirement is met by

PVDF socket fusion fittings from GF.

In socket fusion, attention must be paid to the minimum wall thicknesses of the pipes. The following table in this introduction contains details.

Tools required

Apart from the tools normally used in plastic piping construction, such as pipe cutters or a saw with a cutting guide, the socket fusion joining method requires certain special tools.

Important: The tools described here may be used for GF socket fusion fittings made of PE and PP as well as PVDF.

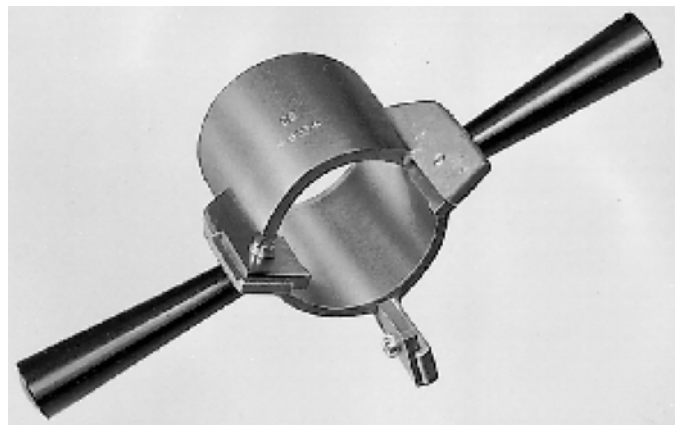

Pipe peeling and chamfering tool

This is used to calibrate the pipe end. This reduces the force exerted to push the pipe into the heating bush, while preventing damage to the surface coating of the heating bush. At the same time the pipe end is chamfered and the insertion depth marked.

Note: Further information on the fusion jointing equipment hire service and training courses are available from GF.

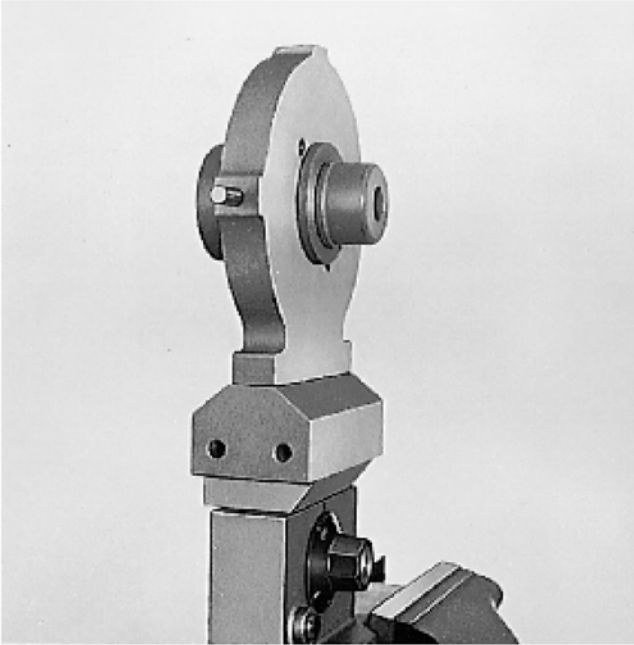

Heating element for manual fusion jointing

The element is heated electrically. The heating bush and spigot are removable. A separate pair is required for each pipe size.

Important: The surfaces of the heating tool which come into contact with the pipe or the fitting must have a non-stick coating.

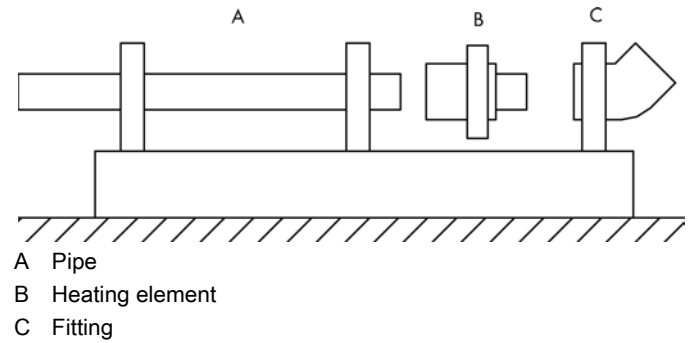

Fusion jointing machine

A fusion jointing machine is recommended for fittings with a diameter of $d = 50$ mm or more. It is also better to use a machine for smaller joints if there is a large number to be made.

The machine should be set up and operated according to its manufacturer's instructions. The procedure detailed below (including the preparation) is for fusion jointing with the help of a manual jointing tool.

Preparation of the fusion joint

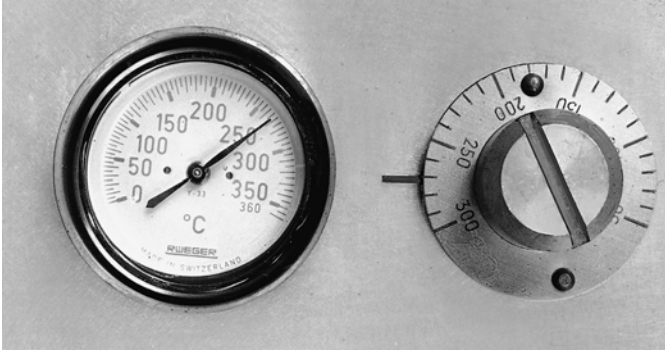

Set the temperature of the heating tool to 260 °C. Check the temperature. The fusion temperature must be between 250 °C and 270 °C. To test the thermostat, check the fusion temperature from time to time on the outside of the heating bush, using a fast acting thermoprobe or tempil sticks (253 °C or 274 °C). This is particularly important when working in strong wind.



Use a clean cloth or dry paper to clean the heating bush and the heating spigot. The tools must be cleaned after making each fusion joint.



Cut the pipe square using a cutter for plastic pipes and deburr the inside edges with a knife.

Make sure that the tools and pipes are clean and grease-free even beyond the fusion zone; if necessary, clean with a cleaning fluid.

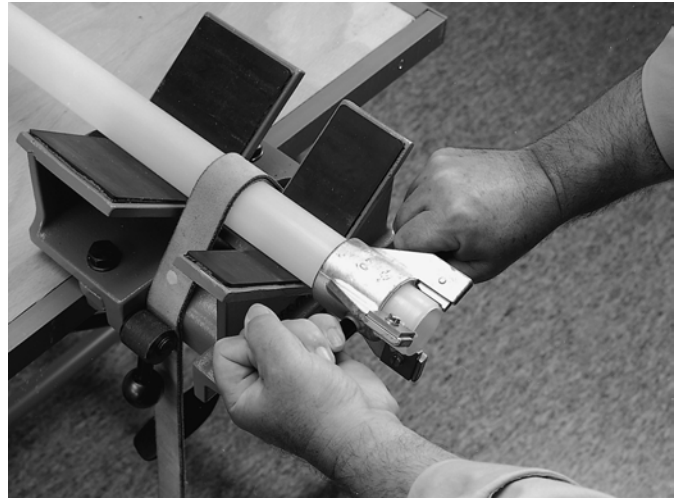

For pipes ranging in size from $d = 20$ to $d = 110$ mm peel the pipe end until the blades are flush with the pipe end.

Should ovality of the pipe prevent the peeling tool from being properly applied, the pipe must first be rounded (e. g. in a vice or with a screw clamp).

Use a scraper to complete the peeling of any area where ovality impairs the effectiveness of the peeling tool.

If the peeling tool can be pushed onto the pipe without removing any material, then the dimensional accuracy of the pipe's outside diameter and of the peeling tool should be checked.

Contact GF for resharpening or replacing the blades. Should this work be carried out independently, use a mandrel gauge to adjust the blades to the following diameters.

Outside pipe diameter d (mm)	Peeled diameter mm	Peeling length l (mm)
16	15.85-15.95	13
20	19.85-19.95	14
25	24.85-24.95	16
32	31.85-31.95	18
40	39.75-39.95	20
50	49.75-49.95	23
63	62.65-62.95	27
75	74.65-74.95	31
90	89.65-89.95	35
110	109.55-109.95	41

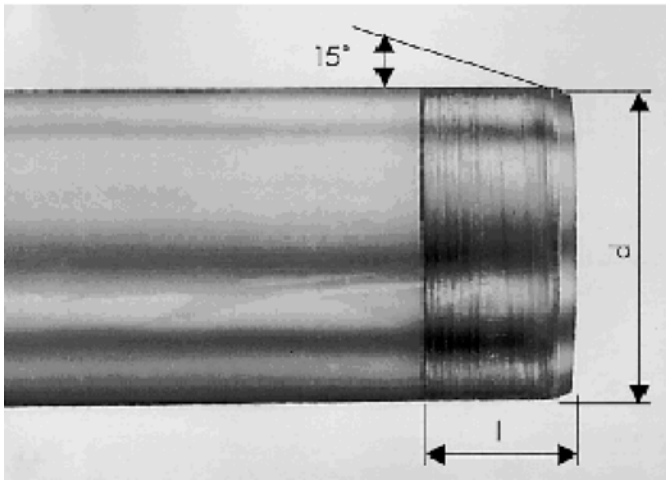

The peeling length l corresponds to the length of the peeling blades.
 For pipes of diameter $d = 16 \text{ mm}$, chamfer about 2 mm of the pipe end at an angle of 15° . Prepare about 15 mm of the pipe end with a scraper. Mark off the jointing length of 13 mm on the pipe.



Thoroughly clean the fitting socket with absorbent paper and cleaning fluid (e. g. Tangit cleaner). Use fresh paper each time.

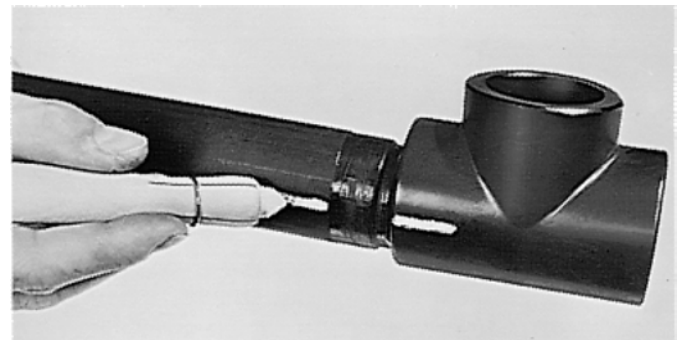

Mark the required position on both the pipe and the fitting before jointing.

Fusion jointing procedure

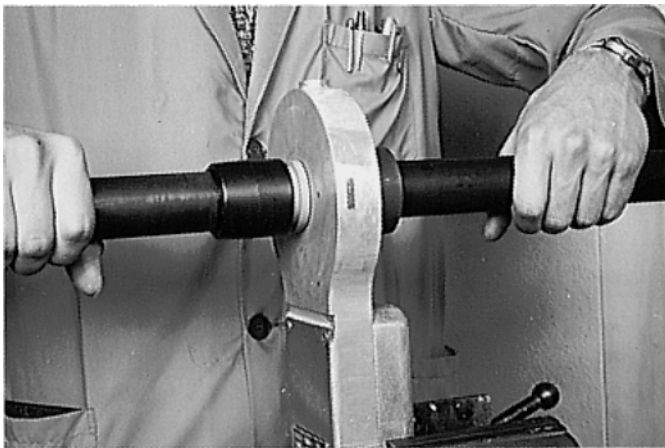

Heating

Quickly push first the fitting onto the heating spigot to the correct depth and then the pipe into the heating bush axially, without twisting, and hold firmly. The heating

times in the table below are measured from this point on. Fusion joints should not be used for pipes whose walls are thinner than those listed in the table.

Heating times and minimum wall thicknesses for socket fusion joints

Pipe outside diameter mm	Minimum pipe wall thickness mm	Heating time sec	Change (Max.-time) sec	Cooling fixed sec	Cooling total min
16	1.5	4	4	6	2
20	1.9	6	4	6	2
25	1.9	8	4	6	2
32	2.4	10	4	12	4
40	2.4	12	4	12	4
50	3.0	18	4	12	4
63	3.0	20	6	18	6
75	3.0	22	6	18	6
90	3.0	25	6	18	6
110	3.0	30	6	24	8

The temperature and heating time must be strictly observed.



Jointing (by hand)

Pull the fitting and pipe from the heating tools with a snap off action as soon as the heating period has elapsed. Paying attention to the alignment marks, immediately















push them together axially without twisting. Hold them together for the same duration as the heating period.

Pressure testing

All fusion joints must be allowed to cool completely before pressure testing, i. e. as a rule wait about an hour

after the last joint has been completed.

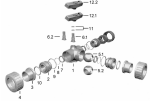
SYGEF® Standard

		Page
	Pipes	31
	Butt Fusion Fittings	32
	Transition Fittings Butt Fusion	40
	Socket Fusion Fittings	42
	Transition Fittings Socket Fusion	51
	Diaphragm valves	53
	Spare Parts Diaphragm Valves	58
 DN10/15 - 50	Ball valves type 546	59
 DN10/15 - 50	Ball valves silicon free/paint compatible	67
 DN10/15 - 50	Spare Parts Ball Valves 546	69
	Spare parts for ball valve type 546 PVDF	74
	Ball valves type 343	76
	Spare Parts Ball Valve 343	84
	Ball check valves	86



Ball check valve silicon free/paint compatible

88

Spare Parts Ball Check Valve 360

90

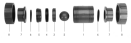

Butterfly valves

91

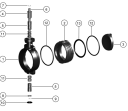

Spare Parts Butterfly Valves

100



Wafer check valves

101

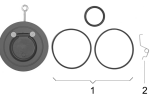

Spare Parts Wafer Check Valve 369

104

Pipes

Pipe, PN 16, PVDF-Standard

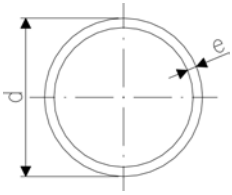

d [mm]	PN	Code	e [mm]	Weight [kg/m]	Length [m]
16	16	175 480 202	1.9	0.171	5.00
20	16	175 480 203	1.9	0.209	5.00
25	16	175 480 204	1.9	0.278	5.00
32	16	175 480 205	2.4	0.425	5.00
40	16	175 480 206	2.4	0.550	5.00
50	16	175 480 207	3.0	0.835	5.00
63	16	175 480 208	3.0	1.080	5.00
75	16	175 480 209	3.6	1.519	5.00
90	16	175 480 210	4.3	2.232	5.00
110	16	175 480 211	5.3	3.336	5.00
140	16	175 480 213	6.7	5.310	5.00
160	16	175 480 214	7.7	6.960	5.00
200	16	175 480 216	9.6	10.800	5.00
225	16	175 480 217	10.8	13.700	5.00

Pipe, PN 10, PVDF-Standard

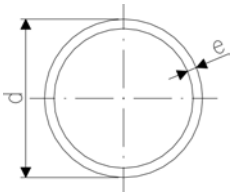

d [mm]	PN	Code	e [mm]	Weight [kg/m]	Length [m]
90	10	175 480 665	2.8	1.565	5.00
110	10	175 480 666	3.4	2.140	5.00
125	10	175 480 667	3.9	2.800	5.00
140	10	175 480 673	4.3	3.710	5.00
160	10	175 480 668	4.9	4.657	5.00
200	10	175 480 669	6.2	6.916	5.00
225	10	175 480 670	6.9	9.162	5.00
250	10	175 480 671	7.7	11.100	5.00
280	10	175 480 656	8.6	13.900	5.00
315	10	175 480 674	9.7	17.600	5.00

Butt Fusion Fittings

Bend 90°, PN 16, PVDF-Standard

- * new model with compact design and optimized flow values

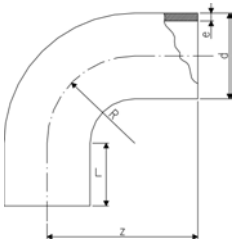

d [mm]	PN	Code	kg	e [mm]	L [mm]	z [mm]	R [mm]
20	16	735 018 706	0.015	1.9	23	38	15
25	16	735 018 707	0.021	1.9	23	42	19
32	16	735 018 708	0.035	2.4	22	46	24
40	16	735 018 709	0.050	2.4	21	51	30
50	16	735 018 710	0.087	3.0	21	58	37
63	16	735 018 711	0.128	3.0	21	66	45
75	16	735 018 712	0.243	3.6	23	75	62
90	16	735 018 713	0.385	4.3	23	90	77
110	16	735 018 714	0.643	5.3	23	110	98
140	16	735 018 716	1.423	6.7	33	140	121
160	16	735 018 717	2.052	7.7	33	160	141
200	16	735 018 719	3.798	9.6	33	200	181
225	16	735 018 720	5.274	10.8	33	220	200

Bend 90°, PN 10, PVDF-Standard

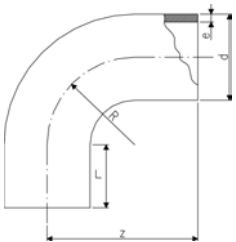
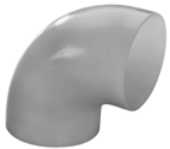

d [mm]	PN	Code	kg	e [mm]	L [mm]	z [mm]	R [mm]
90	10	735 018 513	0.294	2.8	23	90	77
110	10	735 018 514	0.578	3.4	23	110	98
125	10	735 018 515	0.670	3.9	28	125	112
140	10	735 018 516	0.970	4.3	33	140	121
160	10	735 018 517	1.440	4.9	33	160	141
200	10	735 018 519	2.730	6.2	33	200	181
225	10	735 018 520	3.900	6.9	33	220	200

Elbow 90°, PN 16, PVDF-Standard

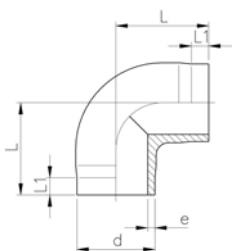

d [mm]	PN	Code	kg	e [mm]	L [mm]	L1 [mm]
20	16	735 108 606	0.017	1.9	38	25
25	16	735 108 607	0.023	1.9	42	26
32	16	735 108 608	0.040	2.4	46	26
40	16	735 108 609	0.060	2.4	51	28
50	16	735 108 610	0.105	3.0	58	28
63	16	735 108 611	0.180	3.0	66	28

Elbow 45°, PN 16, PVDF-Standard

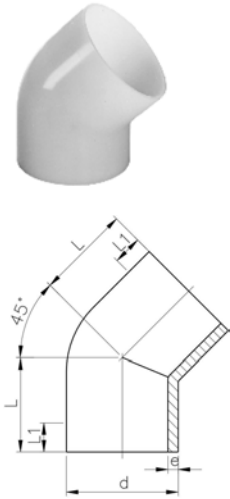

d [mm]	PN	Code	kg	e [mm]	L [mm]	L1 [mm]
20	16	735 158 606	0.014	1.9	32	25
25	16	735 158 607	0.019	1.9	34	26
32	16	735 158 608	0.033	2.4	36	26
40	16	735 158 609	0.048	2.4	39	28
50	16	735 158 610	0.079	3.0	42	30
63	16	735 158 611	0.116	3.0	47	31
75	16	735 158 612	0.160	3.6	49	32
90	16	735 158 613	0.260	4.3	57	37
110	16	735 158 614	0.480	5.3	70	46
140	16	735 158 616	1.000	6.7	88	57
160	16	735 158 617	1.470	7.7	100	62
200	16	735 158 619	2.800	9.6	124	77
225	16	735 158 620	4.000	10.8	140	88

Elbow 45°, PN 10, PVDF-Standard

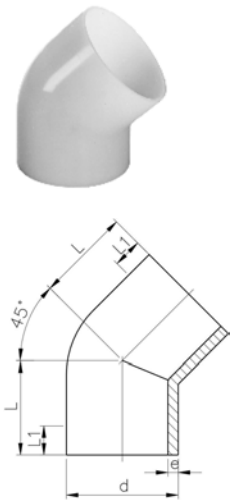

d [mm]	PN	Code	kg	e [mm]	L [mm]	L1 [mm]
90	10	735 158 513	0.181	2.8	57	37
110	10	735 158 514	0.330	3.4	70	46
125	10	735 158 515	0.490	3.9	79	51
140	10	735 158 516	0.680	4.3	88	57
160	10	735 158 517	0.990	4.9	100	62
200	10	735 158 519	1.940	6.2	124	77
225	10	735 158 520	2.780	6.9	140	88

T 90° equal, PN 16, PVDF-Standard

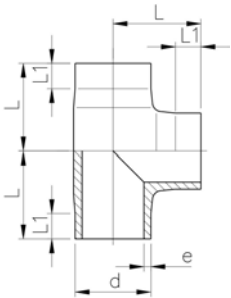

d [mm]	PN	Code	kg	e [mm]	L [mm]	L1 [mm]
20	16	735 208 606	0.023	1.9	38	25
25	16	735 208 607	0.032	1.9	42	27
32	16	735 208 608	0.056	2.4	46	27
40	16	735 208 609	0.083	2.4	51	28
50	16	735 208 610	0.140	3.0	58	28
63	16	735 208 611	0.231	3.0	66	28
75	16	735 208 612	0.370	3.6	75	32
90	16	735 208 613	0.660	4.3	90	39
110	16	735 208 614	1.210	5.3	110	48
140	16	735 208 616	2.600	6.7	140	62
160	16	735 208 617	3.500	7.7	160	71
200	16	735 208 619	7.500	9.6	200	80
225	16	735 208 620	10.600	10.8	220	86

T 90° equal, PN 10, PVDF-Standard

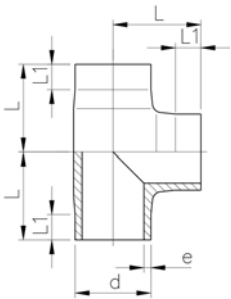

d [mm]	PN	Code	kg	e [mm]	L [mm]	L1 [mm]
90	10	735 208 513	0.397	2.8	90	39
110	10	735 208 514	0.714	3.4	110	48
125	10	735 208 515	1.280	3.9	125	56
140	10	735 208 516	1.780	4.3	140	62
160	10	735 208 517	2.570	4.9	160	71
200	10	735 208 519	4.297	6.2	200	80
225	10	735 208 520	7.250	6.9	220	86

T 90° reduced, PN 16, PVDF-Standard

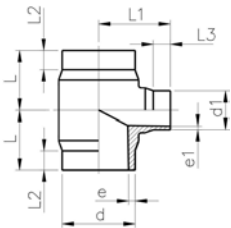

d - d1 [mm]	PN	Code	kg	e [mm]	e1 [mm]	L [mm]	L1 [mm]	L2 [mm]	L3 [mm]
160 - 90	16	735 208 662	3.200	7.7	4.3	155	130	60	25
160 - 110	16	735 208 661	3.300	7.7	5.3	155	130	60	25
225 - 90	16	735 208 670	6.000	10.8	4.3	155	160	60	25
225 - 110	16	735 208 669	6.100	10.8	5.3	155	160	60	25

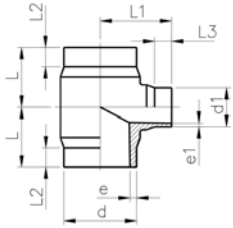

T 90° reduced, PN 10, PVDF-Standard

d - d1 [mm]	PN	Code	kg	e [mm]	e1 [mm]	L [mm]	L1 [mm]	L2 [mm]	L3 [mm]
160 - 90	10	735 208 562	2.300	4.9	4.3	155	130	60	25
160 - 110	10	735 208 561	2.300	4.9	5.3	155	130	60	25
225 - 90	10	735 208 570	4.400	6.9	4.3	155	160	60	25
225 - 110	10	735 208 569	4.400	6.9	5.3	155	160	60	25

Flange Adaptor, PN 16, jointing face serrated, PVDF-Standard

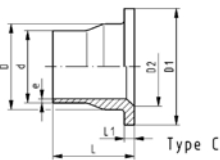
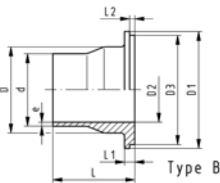
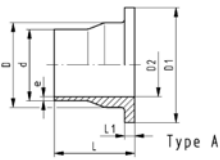

d [mm]	DN [mm]	PN	Code	kg	D [mm]	D1 [mm]	D2 [mm]	D3 [mm]	e [mm]	L [mm]	L1 [mm]	L2 [mm]	Type
20	15	16	735 798 806	0.029	26	45	15		1.9	54	6		A
25	20	16	735 798 807	0.044	32	58	20	54	1.9	56	7	4	B
32	25	16	735 798 808	0.066	40	68	26	63	2.4	58	7	4	B
40	32	16	735 798 809	0.093	49	78	34	73	2.4	68	8	4	B
50	40	16	735 798 810	0.129	60	88	43	82	3.0	69	8	4	B
63	50	16	735 798 811	0.187	75	102	56		3.0	72	9		A
75	65	16	735 798 812	0.298	89	122	66		3.6	80	10		A
90	80	16	735 798 813	0.377	105	138	78	133	4.3	81	12	4	B
110	100	16	735 798 814	0.630	125	158	100		5.3	81	13		C
140	125	16	735 798 816	0.847	155	188	127		6.7	90	16		C
160	150	16	735 798 817	1.200	175	212	151		7.7	93	17		C
200	200	16	735 798 819	1.900	232	268	203		9.6	102	22		C
225	200	16	735 798 820	2.000	235	268	203		10.8	102	22		C

Flange Adaptor, PN 10, jointing face serrated, PVDF-Standard

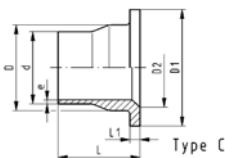
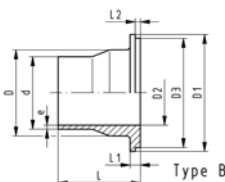
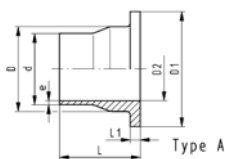

d [mm]	DN [mm]	PN	Code	kg	D [mm]	D1 [mm]	D2 [mm]	D3 [mm]	e [mm]	L [mm]	L1 [mm]	L2 [mm]	Type
90	80	10	735 798 863	0.350	105	138	78	133	2.8	81	12	4	B
110	100	10	735 798 864	0.450	125	158	100		3.4	81	13		A
125	100	10	735 798 565	0.480	132	158	114		3.9	82	14		A
140	125	10	735 798 866	0.710	155	188	127		4.3	90	16		A
160	150	10	735 798 867	1.000	175	212	151		4.9	93	17		C
200	200	10	735 798 869	1.700	232	268	203		6.2	102	22		C
225	200	10	735 798 870	1.600	235	268	203		6.9	102	22		A

Flange Adaptor, PN 16, inch ANSI, jointing face serrated, PVDF-Standard

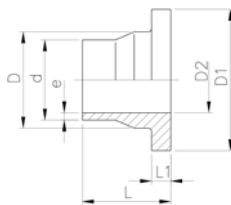

Model:

- Other dimensions identical with metric version

d [mm]	d [inch]	PN	Code	kg	D [mm]	D1 [mm]	D2 [mm]	e [mm]	L [mm]	L1 [mm]
25	¾	16	735 798 857	0.043	32	54	20	1.9	56	7
32	1	16	735 798 858	0.063	40	63	26	2.4	58	7
40	1 ¼	16	735 798 859	0.089	49	73	34	2.4	68	8
50	1 ½	16	735 798 860	0.123	60	82	43	3.0	69	8
90	3	16	735 798 861	0.362	105	133	78	4.3	81	12

Reducer, PN 16, PVDF-Standard

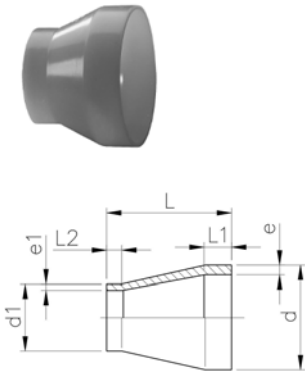

d - d1 [mm]	PN	Code	kg	e [mm]	e1 [mm]	L [mm]	L1 [mm]	L2 [mm]	
25 - 20	16	735 908 637	0.012	1.9	1.9	50	22	22	
32 - 20	16	735 908 642	0.017	2.4	1.9	50	22	22	
32 - 25	16	735 908 641	0.018	2.4	1.9	50	22	22	
40 - 20	16	735 908 648	0.024	2.4	1.9	58	22	24	
40 - 25	16	735 908 647	0.025	2.4	1.9	55	22	24	
40 - 32	16	735 908 646	0.029	2.4	2.4	55	22	24	
50 - 25	16	735 908 654	0.031	3.0	1.9	60	22	25	
50 - 32	16	735 908 653	0.038	3.0	2.4	60	22	25	
50 - 40	16	735 908 652	0.040	3.0	2.4	60	22	25	
63 - 32	16	735 908 660	0.050	3.0	2.4	65	22	25	
63 - 40	16	735 908 659	0.052	3.0	2.4	65	22	25	
63 - 50	16	735 908 658	0.060	3.0	3.0	65	22	25	
75 - 40	16	735 908 666	0.069	3.6	2.4	68	24	25	
75 - 50	16	735 908 665	0.078	3.6	3.0	65	24	25	
75 - 63	16	735 908 664	0.080	3.6	3.0	65	24	25	
90 - 63	16	735 908 671	0.120	4.3	3.0	75	25	30	
90 - 75	16	735 908 670	0.130	4.3	3.6	75	25	35	
110 - 63	16	735 908 678	0.225	5.3	3.0	90	30	30	
110 - 75	16	735 908 677	0.213	5.3	3.6	90	30	35	
110 - 90	16	735 908 676	0.230	5.3	4.3	90	30	35	
140 - 110	16	735 908 685	0.450	6.7	5.3	110	40	40	
160 - 110	16	735 908 690	0.650	10.8	9.6	160	55	50	
160 - 140	16	735 908 688	0.450	7.7	5.3	120	40	40	
200 - 160	16	735 908 692	1.340	7.7	6.7	120	40	35	
225 - 110	16	735 908 695	1.540	10.8	5.3	160	50	40	
225 - 160	16	735 908 696	1.730	10.8	5.3	160	50	40	
225 - 200	16	735 908 697	1.980	10.8	7.7	160	55	28	

Reducer, PN 10, PVDF-Standard

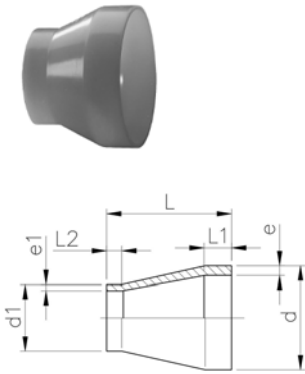

d - d1 [mm]	PN [bar]	Code	kg	e [mm]	e1 [mm]	L [mm]	L1 [mm]	L2 [mm]	
90 - 63	10 / 16	735 908 551	0.102	2.8	3.0	75	25	30	
110 - 63	10 / 16	735 908 553	0.164	3.4	3.0	90	30	30	
110 - 90	10 / 10	735 908 555	0.167	3.4	2.8	90	30	35	
125 - 110	10 / 16	735 908 580	0.270	3.9	5.3	100	35	40	
140 - 110	10 / 16	735 908 585	0.385	4.3	5.3	110	40	40	
140 - 125	10 / 10	735 908 584	0.340	4.3	3.9	110	40	40	
160 - 110	10 / 10	735 908 561	0.449	4.9	3.4	120	40	40	
160 - 110	10 / 16	735 908 590	0.425	4.9	5.3	120	40	40	
160 - 140	10 / 10	735 908 588	0.460	4.9	4.3	120	40	40	
200 - 160	10 / 10	735 908 592	0.830	6.2	4.9	145	50	40	
225 - 110	10 / 10	735 908 566	1.120	6.9	3.4	160	55	35	
225 - 110	10 / 16	735 908 595	0.940	6.9	5.3	160	55	35	
225 - 160	10 / 10	735 908 596	1.140	6.9	4.9	160	55	40	
225 - 200	10 / 10	735 908 597	1.200	6.9	6.2	160	55	50	



Union (FPM black), PN 16, PVDF-Standard

Model:

- supplied with sealing
- d75, d90 and d110 with buttress shaped thread

Note:

- For the dimensions d75-110 please see instructions for the installation

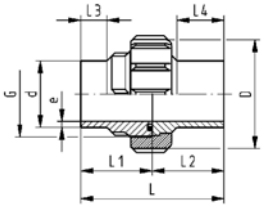

d [mm]	PN	Code	kg	D [mm]	e [mm]	L [mm]	L1 [mm]	L2 [mm]	L3 [mm]
20	16	735 528 606	0.081	45	1.9	107	53	53	25
25	16	735 528 607	0.123	55	1.9	112	56	56	25
32	16	735 528 608	0.167	62	2.4	119	59	59	25
40	16	735 528 609	0.269	75	2.4	125	62	63	25
50	16	735 528 610	0.370	84	3.0	130	65	66	25
63	16	735 528 611	0.592	101	3.0	136	68	69	25
75	16	735 528 612	0.740	133	3.6	131	66	66	24
90	16	735 528 613	0.730	133	4.3	131	66	65	24
110	16	735 528 614	1.020	155	5.3	131	66	65	25



Union end, PN 16, PVDF-Standard

Model:

- Suitable for SYGEF® Standard Union Butt Fusion
- Suitable for Diaphragm Valve Type 314
- Suitable for Vortex Sensor

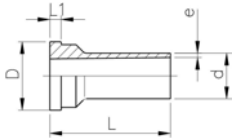

d [mm]	PN	Code	kg	D [mm]	e [mm]	L [mm]	L1 [mm]
20	16	735 608 606	0.020	30	1.9	53	5
25	16	735 608 607	0.029	39	1.9	56	5
32	16	735 608 608	0.041	45	2.4	59	6
40	16	735 608 609	0.069	57	2.4	63	6
50	16	735 608 610	0.094	63	3.0	66	7
63	16	735 608 611	0.144	78	3.0	69	8
75	16	735 608 612	0.188	101	3.6	66	9
90	16	735 608 613	0.184	101	4.3	65	9
110	16	735 608 614	0.260	121	5.3	65	10



Union bush, PN 16, PVDF-Standard

Model:

- Suitable for SYGEF® Standard Union Butt Fusion
- d75, d90 and d110 with buttress shaped thread

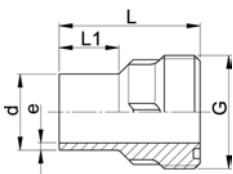

d [mm]	PN	Code	kg	G [inch]	e [mm]	L [mm]	L1 [mm]
20	16	735 648 606	0.029		1	1.9	53
25	16	735 648 607	0.045		1 1/4	4.9	56
32	16	735 648 608	0.063		1 1/2	2.4	59
40	16	735 648 609	0.098		2	2.4	62
50	16	735 648 610	0.124		2 1/4	3.0	65
63	16	735 648 611	0.195		2 3/4	3.0	68
75	16	735 648 612	0.272		S 107.5 x 3.6	3.6	66
90	16	735 648 613	0.273		S 107.5 x 3.6	4.3	66
110	16	735 648 614	0.364		S 127.5 x 3.6	5.3	66

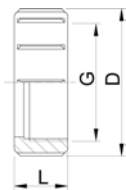

Union nut, PN16, PVDF-Standard

- d75, d90 and d110 with butress shaped thread

Note:

- For the dimensions d75-110 please see instructions for the installation

Socket Fusion d [mm]	Butt Fusion d [mm]	PN	Code	kg	D [mm]	G [inch]	L [mm]
16	16	16	735 690 405	0.013	35	3/4	21
20	20	16	735 690 406	0.023	45	1	22
25	25	16	735 690 407	0.047	55	1 1/4	24
32	32	16	735 690 408	0.048	62	1 1/2	26
40	40	16	735 690 409	0.097	75	2	29
50	50	16	735 690 410	0.146	84	2 1/4	33
63	63	16	735 690 411	0.145	101	2 3/4	35
75	75 - 90	16	735 690 422	0.290	133	S 107,5x3,6	40
90	110	16	735 690 423	0.420	155	S 127,5x3,6	42
110	-	16	735 690 424	0.650	185	S 152,5x3,6	47

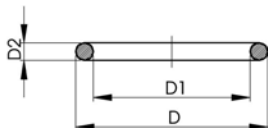

O-Ring, FPM black

Note:

- For the dimensions d75-110 please see instructions for the installation

d [mm]	DN [mm]	Code	SP	kg	D [mm]	D1 [mm]	D2 [mm]
16	10	749 410 005	-	0.002	21	16	3
20	15	749 410 006	-	0.002	27	20	4
25	20	749 410 007	100	0.002	35	28	4
32	25	749 410 008	100	0.002	40	33	4
40	32	749 410 009	-	0.006	51	41	5
50	40	749 410 010	-	0.007	58	47	5
63	50	749 410 011	100	0.010	70	60	5
63	50	749 410 013	100	0.011	80	69	5
75	65	749 410 014	100	0.012	93	82	5
90	80	749 410 015	100	0.015	112	101	5

Transition Fittings Butt Fusion

Adaptor Nipple, male thread - R, PN 16, PVDF-Standard

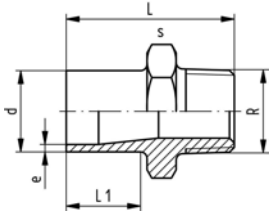

Model:

- With butt fusion spigot and BSP tapered male thread
- Connection to plastic thread only
- Do not use thread sealing pastes that are harmful to PVDF
- Avoid stresses when installing and large changes in temperature

d [mm]	R [inch]	PN	Code	kg	e [mm]	L [mm]	s [mm]	L1 [mm]
20	3/8	16	735 910 555	0.023	1.9	50	32	26
20	3/8	16	735 910 556	0.025	1.9	53	32	26
25	3/4	16	735 910 557	0.032	1.9	55	36	26
32	1	16	735 910 558	0.051	2.4	57	46	26
40	1 1/4	16	735 910 559	0.075	2.4	60	55	26
50	1 1/2	16	735 910 560	0.112	3.0	63	65	26
63	2	16	735 910 561	0.179	3.0	69	75	27

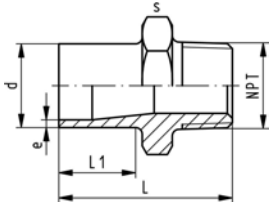

Adaptor Nipple, male thread - NPT, PN 16, PVDF-Standard

Model:

- With butt fusion spigot and taper male thread
- Connection to plastic thread only
- Do not use thread sealing pastes that are harmful to PVDF
- Avoid stresses when installing and large changes in temperature

d [mm]	NPT [inch]	PN	Code	kg	e [mm]	L [mm]	s [mm]	L1 [mm]
20	3/8	16	735 914 555	0.023	1.9	50	32	28
20	1/2	16	735 914 556	0.025	1.9	53	32	28
25	3/4	16	735 914 557	0.032	1.9	55	36	28
32	1	16	735 914 558	0.052	2.4	57	46	28
40	1 1/4	16	735 914 559	0.075	2.4	60	55	28
50	1 1/2	16	735 914 560	0.112	3.0	63	65	28
63	2	16	735 914 561	0.179	3.0	69	75	29

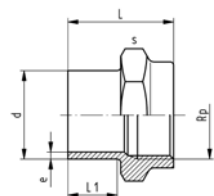

Adaptor Socket, female thread - Rp, PN16, PVDF-Standard

Model:

- With butt fusion spigot and BSP parallel female thread
- Connection to plastic thread only
- Do not use thread sealing pastes that are harmful to PVDF
- Avoid stresses when installing and large changes in temperature

d [mm]	Rp [inch]	PN	Code	kg	e [mm]	L [mm]	s [mm]	L1 [mm]
20	3/8	16	735 910 265	0.030	1.9	49	32	23
20	1/2	16	735 910 266	0.026	1.9	49	32	23
25	3/4	16	735 910 267	0.032	1.9	51	36	23
32	1	16	735 910 268	0.058	2.4	54	46	23
40	1 1/4	16	735 910 269	0.079	2.4	56	55	23
50	1 1/2	16	735 910 270	0.100	3.0	60	65	24
63	2	16	735 910 271	0.001	3.0	62	75	23

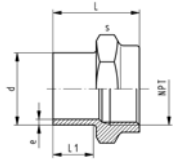

Adaptor Socket, female thread - NPT, PN 16, PVDF-Standard

Model:

- With butt fusion spigot and taper female thread
- Connection to plastic thread only
- Do not use thread sealing pastes that are harmful to PVDF
- Avoid stresses when installing and large changes in temperature

d [mm]	NPT [inch]	PN	Code	kg	e [mm]	L [mm]	s [mm]	L1 [mm]
20	3/8	16	735 914 265	0.030	1.9	49	32	28
20	1/2	16	735 914 266	0.026	1.9	49	32	28
25	3/4	16	735 914 267	0.032	1.9	51	36	28
32	1	16	735 914 268	0.058	2.4	54	46	28
40	1 1/4	16	735 914 269	0.079	2.4	57	55	28
50	1 1/2	16	735 914 270	0.001	3.0	60	65	28
63	2	16	735 914 271	0.001	3.0	64	75	29

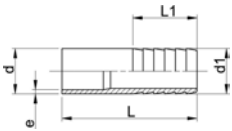

Hose Adapter, PN 16, PVDF-Standard

Model:

- With butt fusion spigot

d - d1 [mm]	PN	e [mm]	L [mm]	L1 [mm]	Code	kg
20 - 20	16	1.9	64	27	735 968 606	0.001
25 - 25	16	1.9	75	36	735 968 607	0.001
32 - 32	16	2.4	82	36	735 968 608	0.042
40 - 40	16	2.4	84	42	735 968 609	0.001
50 - 50	16	3.0	90	48	735 968 610	0.084
63 - 60	16	3.0	100	50	735 968 611	0.118

Socket Fusion Fittings

Elbow 90°, PN 16, PVDF-Standard

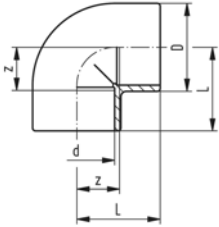

d [mm]	PN	Code	kg	D [mm]	L [mm]	z [mm]
16	16	735 100 105	0.029	26	25	12
20	16	735 100 106	0.026	27	28	14
25	16	735 100 107	0.038	32	32	16
32	16	735 100 108	0.065	40	38	20
40	16	735 100 109	0.104	49	44	24
50	16	735 100 110	0.164	60	51	28
63	16	735 100 111	0.284	75	62	35

Elbow 45°, PN 16, PVDF-Standard

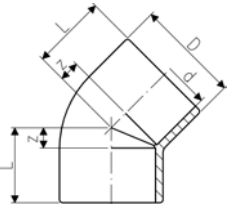

d [mm]	PN	Code	kg	D [mm]	L [mm]	z [mm]
16	16	735 150 105	0.017	23	20	7
20	16	735 150 106	0.020	27	21	7
25	16	735 150 107	0.030	32	24	8
32	16	735 150 108	0.051	40	28	10
40	16	735 150 109	0.083	49	33	13
50	16	735 150 110	0.123	60	36	13
63	16	735 150 111	0.211	75	43	16



T 90° equal, PN 16, PVDF-Standard

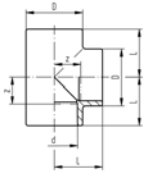
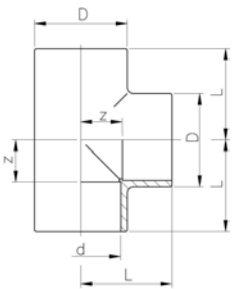

d [mm]	PN	Code	kg	D [mm]	L [mm]	z [mm]
16	16	735 200 105	0.039	26	25	12
20	16	735 200 106	0.035	27	28	14
25	16	735 200 107	0.050	32	32	16
32	16	735 200 108	0.085	40	38	20
40	16	735 200 109	0.135	49	44	24
50	16	735 200 110	0.208	60	51	28
63	16	735 200 111	0.360	75	62	35



Flange Adaptor with groove, PN 16, PVDF-Standard

Model:

- Jointing face: with O-ring groove
- Counterpart: Flange Adaptor metric or ANSI
- Gasket: O-ring EPDM No. 48 41 01, FPM No. 49 41 01

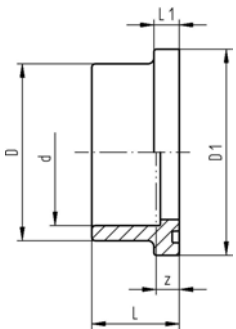
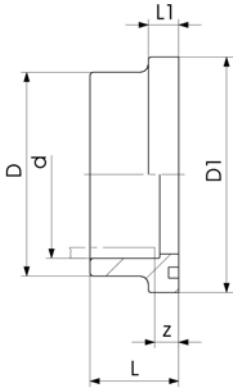

d [mm]	PN	Code	kg	D [mm]	D1 [mm]	L [mm]	L1 [mm]	z [mm]
20	16	735 810 106	0.015	27	34	22	9	8
25	16	735 810 107	0.022	33	41	24	10	8
32	16	735 810 108	0.036	41	50	26	10	8
40	16	735 810 109	0.055	50	61	30	13	10
50	16	735 810 110	0.080	61	73	33	13	10
63	16	735 810 111	0.138	76	90	37	14	10



Flange Adaptor metric, PN 16, jointing face serrated, PVDF-Standard

Model:

- Increased face dimension metric
- Suitable for Flange Adaptor with groove
- Gasket: Profile Flange Gaskets **FPM** or **EPDM**
- Gasket: Flat Gasket **FPM** or **EPDM**

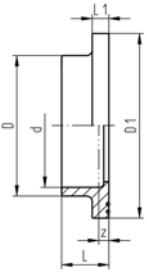
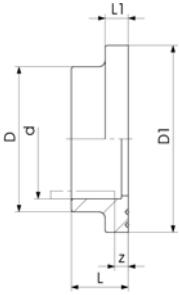

d [mm]	DN [mm]	PN	Code	kg	D [mm]	D1 [mm]	L [mm]	L1 [mm]	z [mm]
20	15	16	735 790 206	0.020	27	45	19	6	3
25	20	16	735 790 207	0.037	33	58	21	7	3
32	25	16	735 790 208	0.051	41	68	23	7	3
40	32	16	735 790 209	0.073	50	78	25	8	3
50	40	16	735 790 210	0.095	61	88	28	8	3
63	50	16	735 790 211	0.142	76	102	32	9	3



Flange Adaptor, PN 16, jointing face serrated, ANSI, PVDF-Standard

Model:

- Suitable for Flange Adaptor with groove
- Face dimension ANSI
- Gasket: Flat Gasket **FPM** or **EPDM**
- Gasket: Profile Flange Gaskets **FPM** or **EPDM**
- Dimensions d20 and d63 are identical to metric version

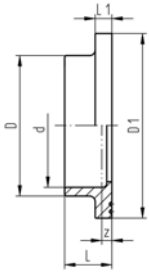
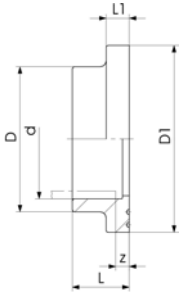

d [mm]	d [inch]	PN	Code	kg	D [mm]	D1 [mm]	L [mm]	L1 [mm]	z [mm]
25	¾	16	735 790 257	0.037	33	54	21	7	3
32	1	16	735 790 258	0.051	41	63	23	7	3
40	1 ¼	16	735 790 259	0.073	50	73	25	8	3
50	1 ½	16	735 790 260	0.095	61	82	28	8	3



Reducing Bush, PN 16, PVDF-Standard

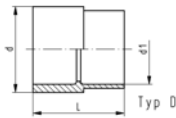
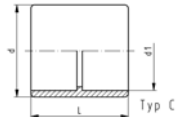
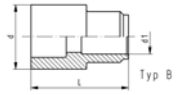
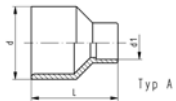

d - d1 [mm]	PN	Code	kg	L [mm]	z [mm]	Type
20 - 16	16	735 910 334	0.017	35	22	B
25 - 20	16	735 910 337	0.017	37	23	A
32 - 20	16	735 910 342	0.022	43	29	A
32 - 25	16	735 910 341	0.023	39	23	C
40 - 20	16	735 910 348	0.033	48	34	A
40 - 25	16	735 910 347	0.037	48	32	A
40 - 32	16	735 910 346	0.037	43	25	C
50 - 20	16	735 910 355	0.059	54	40	A
50 - 25	16	735 910 354	0.058	54	38	A
50 - 32	16	735 910 353	0.062	54	36	A
50 - 40	16	735 910 352	0.063	48	28	C
63 - 20	16	735 910 362	0.103	64	50	A
63 - 25	16	735 910 361	0.105	64	48	A
63 - 32	16	735 910 360	0.108	64	46	A
63 - 40	16	735 910 359	0.117	64	44	A
63 - 50	16	735 910 358	0.105	54	31	D

Overview about functionality

Main function							Additional functions											
Reduction Spigot - Socket							Reduction Socket - Socket				Reduction Spigot - Spigot				Reduktion Socket - Spigot			
Code	PN	L	Spigot d	Socket d ₁	L	Z	Socket d	Socket d ₁	L	Z	Spigot d	Spigot d ₁	L	Z	Socket d	Spigot d ₁	L	Z
735 910 334	16	35	20	16	35	22												
735 910 337	16	37	25	20	37	23												
735 910 342	16	43	32	20	43	29	25	20	43	13								
735 910 341	16	39	32	25	39	23												
735 910 348	16	48	40	20	48	34	32	20	48	16								
735 910 347	16	48	40	25	48	32	32	25	48	14	40	32	48	48				
735 910 346	16	43	40	32	43	25												
735 910 355	16	54	50	20	54	40	40	20	54	20								
735 910 354	16	54	50	25	54	38	40	25	54	18	50	32	54	54	40	32	54	34
735 910 353	16	54	50	32	54	36	40	32	54	16	50	40	54	54				
735 910 352	16	48	50	40	48	28												
735 910 362	16	64	63	20	64	50	50	20	64	27								
735 910 361	16	64	63	25	64	48	50	25	64	25	63	32	64	64	50	32	64	41
735 910 360	16	64	63	32	64	46	50	32	64	23	63	40	64	64	50	40	64	41
735 910 359	16	64	63	40	64	44	50	40	64	21	63	50	64	64				
735 910 358	16	54	63	50	54	31												

Please note: Illustration of the functions not inevitably conform to respective type!

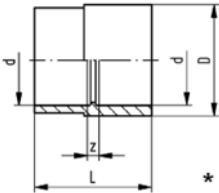
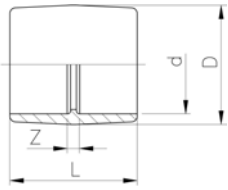

Socket equal, PN 16, PVDF-Standard

d [mm]	PN	Code	kg	D [mm]	L [mm]	z [mm]
16	16	735 910 105	0.020	26	33	7
20	16	735 910 106	0.016	27	35	7
25	16	735 910 107	0.023	32	39	7
32	16	735 910 108	0.037	40	43	7
*40	16	735 910 109	0.063	50	48	8
*50	16	735 910 110	0.105	63	54	8
63	16	735 910 111	0.146	75	62	8

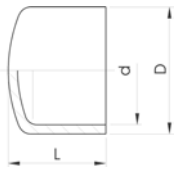

Cap, PN 16, PVDF-Standard

d [mm]	PN	Code	kg	D [mm]	L [mm]
16	16	735 960 105	0.013	25	24
20	16	735 960 106	0.011	27	23
25	16	735 960 107	0.017	32	26
32	16	735 960 108	0.028	40	30
40	16	735 960 109	0.045	49	34
50	16	735 960 110	0.073	60	39
63	16	735 960 111	0.128	75	46

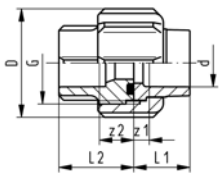

Union (FPM black), PN 16, PVDF-Standard

- Supplied with: O-Ring No. 49 41 00 FPM (e.g. Viton A®)
- Please see installation instruction

d [mm]	PN	Code	kg	D [mm]	G [inch]	L1 [mm]	L2 [mm]	z1 [mm]	z [mm]
16	16	735 510 105	0.025	35	3/4	18	24	5	11
20	16	735 510 106	0.064	45	1	19	26	5	12
25	16	735 510 107	0.101	55	1 1/4	21	28	5	12
32	16	735 510 108	0.132	62	1 1/2	23	30	5	12
40	16	735 510 109	0.219	75	2	25	34	5	14
50	16	735 510 110	0.289	84	2 1/4	28	39	5	16
63	16	735 510 111	0.496	101	2 3/4	32	47	5	20



Union end, PN 16, PVDF-Standard

Model:

- Suitable for SYGEF® Standard Union Socket Fusion
- Suitable for Diaphragm Valve Type 314
- Suitable for Vortex Sensor

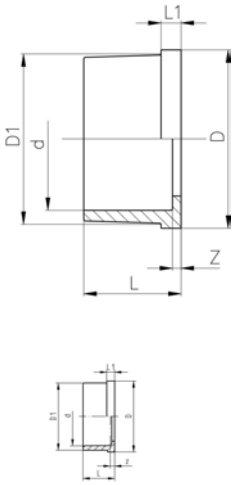

d [mm]	PN	Code	kg	D [mm]	D1 [mm]	L [mm]	L1 [mm]	z [mm]
16	16	735 600 105	0.006	24	22	18	4	5
20	16	735 600 106	0.011	30	28	19	5	5
25	16	735 600 107	0.022	39	36	21	5	5
32	16	735 600 108	0.026	45	42	23	6	5
40	16	735 600 109	0.046	57	53	25	6	5
50	16	735 600 110	0.054	63	59	28	7	5
63	16	735 600 111	0.079	78	74	32	7	5



Union bush, PN 16, PVDF-Standard

Model:

- Suitable for SYGEF® Standard Union Socket Fusion

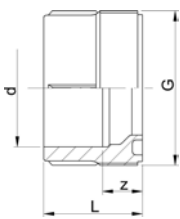

d [mm]	PN	Code	kg	G [inch]	L [mm]	z [mm]
16	16	735 640 105	0.011	3/4	24	11
20	16	735 640 106	0.019	1	26	12
25	16	735 640 107	0.031	1 1/4	28	12
32	16	735 640 108	0.042	1 1/2	30	12
40	16	735 640 109	0.069	2	34	14
50	16	735 640 110	0.091	2 1/4	39	16
63	16	735 640 111	0.161	2 3/4	47	20



Union nut, PN16, PVDF-Standard

- d75, d90 and d110 with buttress shaped thread

Note:

- For the dimensions d75-110 please see instructions for the installation

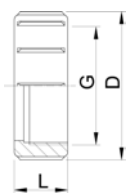

Socket Fusion d [mm]	Butt Fusion d [mm]	PN	Code	kg	D [mm]	G [inch]	L [mm]
16	16	16	735 690 405	0.013	35	3/4	21
20	20	16	735 690 406	0.023	45	1	22
25	25	16	735 690 407	0.047	55	1 1/4	24
32	32	16	735 690 408	0.048	62	1 1/2	26
40	40	16	735 690 409	0.097	75	2	29
50	50	16	735 690 410	0.146	84	2 1/4	33
63	63	16	735 690 411	0.145	101	2 3/4	35
75	75 - 90	16	735 690 422	0.290	133	S 107,5x3,6	40
90	110	16	735 690 423	0.420	155	S 127,5x3,6	42
110	-	16	735 690 424	0.650	185	S 152,5x3,6	47



O-Ring, FPM black

Note:

- For the dimensions d75-110 please see instructions for the installation

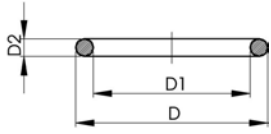

d [mm]	DN [mm]	Code	SP	kg	D [mm]	D1 [mm]	D2 [mm]
16	10	749 410 005	-	0.002	21	16	3
20	15	749 410 006	-	0.002	27	20	4
25	20	749 410 007	100	0.002	35	28	4
32	25	749 410 008	100	0.002	40	33	4
40	32	749 410 009	-	0.006	51	41	5
50	40	749 410 010	-	0.007	58	47	5
63	50	749 410 011	100	0.010	70	60	5
63	50	749 410 013	100	0.011	80	69	5
75	65	749 410 014	100	0.012	93	82	5
90	80	749 410 015	100	0.015	112	101	5

Transition Fittings Socket Fusion

Adaptor Nipple, male thread - R, PN 16, PVDF-Standard

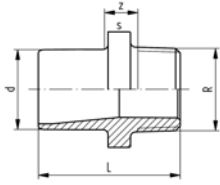

Model:

- With socket fusion spigot metric and BSP tapered male thread
- Connection to plastic thread only
- Do not use thread sealing pastes that are harmful to PVDF
- Avoid stresses when installing and large changes in temperature

d [mm]	R [inch]	PN	Code	kg	L [mm]	s [mm]	z [mm]
16	3/8	16	735 910 505	0.015	37	27	12
20	1/2	16	735 910 506	0.025	53	32	25
25	3/4	16	735 910 507	0.032	55	36	24
32	1	16	735 910 508	0.052	57	46	22
40	1 1/4	16	735 910 509	0.076	60	55	21
50	1 1/2	16	735 910 510	0.112	63	65	19
63	2	16	735 910 511	0.163	69	75	18

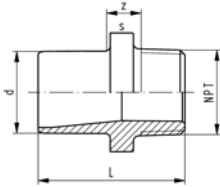

Adaptor Nipple, male thread - NPT, PN 16, PVDF-Standard

Model:

- With socket fusion spigot and taper male thread
- Connection to plastic thread only
- Do not use thread sealing pastes that are harmful to PVDF
- Avoid stresses when installing and large changes in temperature

d [mm]	NPT [inch]	PN	Code	kg	L [mm]	s [mm]	z [mm]
16	3/8	16	735 914 505	0.014	37	27	12
20	1/2	16	735 914 506	0.025	53	32	25
25	3/4	16	735 914 507	0.033	55	36	24
32	1	16	735 914 508	0.052	57	46	22
40	1 1/4	16	735 914 509	0.076	60	55	21
50	1 1/2	16	735 914 510	0.114	63	65	19
63	2	16	735 914 511	0.164	69	75	18



Adaptor Socket, female thread - Rp, PN 16, PVDF-Standard

Model:

- With socket fusion end and parallel female thread
- Connection to plastic thread only
- Do not use thread sealing pastes that are harmful to PVDF
- Avoid stresses when installing and large changes in temperature

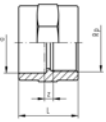
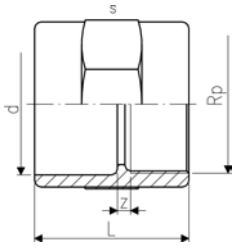

d [mm]	Rp [inch]	PN	Code	kg	L [mm]	s [mm]	z [mm]
20	¾	16	735 910 206	0.030	34	32	5
25	¾	16	735 910 207	0.037	38	36	6
32	1	16	735 910 208	0.067	43	46	7
40	1 ¼	16	735 910 209	0.100	47	55	7
50	1 ½	16	735 910 210	0.135	54	65	9
63	2	16	735 910 211	0.217	62	80	9



Adaptor Socket, female thread - NPT, PN 16, PVDF-Standard

Model:

- With socket fusion end and taper female thread
- Connection to plastic thread only
- Do not use thread sealing pastes that are harmful to PVDF
- Avoid stresses when installing and large changes in temperature

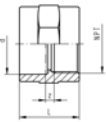
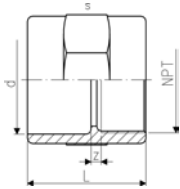

d [mm]	NPT [inch]	PN	Code	kg	L [mm]	s [mm]	z [mm]
16	¾	16	735 914 205	0.016	29	27	3
20	½	16	735 914 206	0.030	34	32	5
25	¾	16	735 914 207	0.036	38	36	6
32	1	16	735 914 208	0.067	43	46	7
40	1 ¼	16	735 914 209	0.100	47	55	7
50	1 ½	16	735 914 210	0.140	54	65	9
63	2	16	735 914 211	0.220	62	80	9



Hose Adapter, PN 16, PVDF-Standard

Model:

- With socket fusion spigot, PN 16

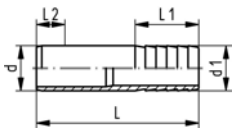

d - d1 [mm]	PN	Code	kg	L [mm]	L1 [mm]	L2 [mm]	z [mm]
16 - 16	16	735 960 405	0.001	50	27	13	10
20 - 20	16	735 960 406	0.001	78	27	14	37
25 - 25	16	735 960 407	0.001	91	36	16	39
32 - 32	16	735 960 408	0.001	100	36	18	46
40 - 40	16	735 960 409	0.160	104	42	20	42
50 - 50	16	735 960 410	0.089	90	48	23	19
63 - 60	16	735 960 411	0.126	100	50	27	23

Diaphragm valves

SYGEF® standard Diaphragm valve type 314 PVDF With fusion sockets metric

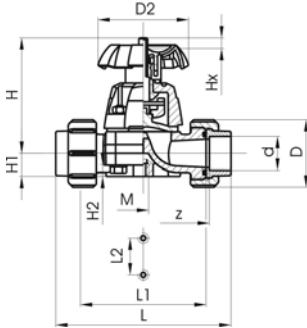

Model:

- Diaphragm PTFE with EPDM backing diaphragm (FDA compliant)
- For easy installation and removal
- Short overall length

Option:

- Handwheel with built-in locking mechanism (standard version is nonlockable)

d [mm]	DN [mm]	PN	kv-value ($\Delta p=1$ bar) [l/min]	PTFE with EPDM supp. Diaphragm Code	kg
20	15	10	72	175 314 432	0.470
25	20	10	137	175 314 433	0.687
32	25	10	207	175 314 434	0.935
40	32	10	354	175 314 435	1.500
50	40	10	517	175 314 436	1.960
63	50	10	713	175 314 437	3.470

d [mm]	D [mm]	D2 [mm]	H [mm]	H1 [mm]	H2 [mm]	L [mm]	L1 [mm]	L2 [mm]	M	z [mm]
20	45	80	90	14	12	128	90	25	M6	100
25	55	80	101	18	12	150	108	25	M6	118
32	62	94	117	22	12	162	116	25	M6	126
40	75	117	127	26	15	184	134	45	M8	144
50	84	117	139	32	15	210	154	45	M8	164
63	101	152	172	39	15	148	184	45	M8	194

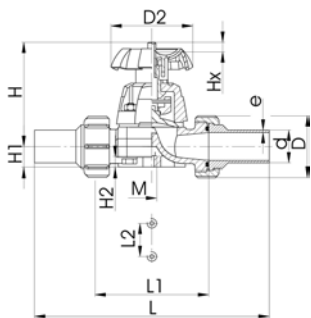

SYGEF® standard Diaphragm valve type 314 PVDF With butt fusion spigots metric

Model:

- Diaphragm PTFE with EPDM backing diaphragm (FDA compliant)
- For easy installation and removal
- Short overall length
- Welding dimension: PN16

Option:

- Handwheel with built-in locking mechanism (standard version is nonlockable)

d [mm]	DN [mm]	PN	kv-value ($\Delta p=1$ bar) [l/min]	PTFE with EPDM supp. Diaphragm Code	kg
20	15	10	72	175 314 532	0.485
25	20	10	137	175 314 533	0.710
32	25	10	207	175 314 534	0.970
40	32	10	354	175 314 535	1.545
50	40	10	517	175 314 536	2.040
63	50	10	713	175 314 537	3.537

d [mm]	D [mm]	D2 [mm]	e [mm]	H [mm]	H1 [mm]	H2 [mm]	L [mm]	L1 [mm]	L2 [mm]	M
20	45	80	1.9	90	14	12	196	90	25	M6
25	55	80	1.9	101	18	12	220	108	25	M6
32	62	94	2.4	117	22	12	234	116	25	M6
40	75	117	2.4	127	26	15	258	134	45	M8
50	84	117	3.0	139	32	15	284	154	45	M8
63	101	152	3.0	172	39	15	320	184	45	M8



SYGEF® standard Diaphragm valve type 315 PVDF With socket fusion spigots metric

Model:

- Diaphragm PTFE with EPDM backing diaphragm (FDA compliant)
- Further versions : with diaphragm FPM on request

Option:

- Handwheel with built-in locking mechanism (standard version is nonlockable)

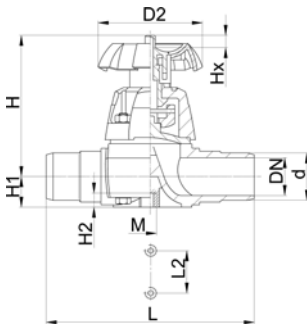

d [mm]	DN [mm]	PN	kv-value ($\Delta p=1$ bar) [l/min]	PTFE with EPDM supp. diaphragm Code	kg	D2 [mm]	H [mm]	H1 [mm]	H2 [mm]	L [mm]	L2 [mm]	M
20	15	10	72	175 315 432	0.350	80	90	14	12	124	25	M6
25	20	10	137	175 315 433	0.570	80	102	18	12	144	25	M6
32	25	10	207	175 315 434	0.805	94	119	21	12	154	25	M6
40	32	10	354	175 315 435	1.000	117	126	26	15	174	45	M8
50	40	10	517	175 315 436	1.500	117	139	33	15	194	45	M8
63	50	10	713	175 315 437	2.680	152	172	39	15	224	45	M8



SYGEF® standard Diaphragm valve type 315 PVDF With butt fusion spigots metric

Model:

- Welding dimension: PN16
- Diaphragm PTFE with EPDM backing diaphragm (FDA compliant)
- Further versions : with diaphragm FPM on request

Option:

- Handwheel with built-in locking mechanism (standard version is nonlockable)

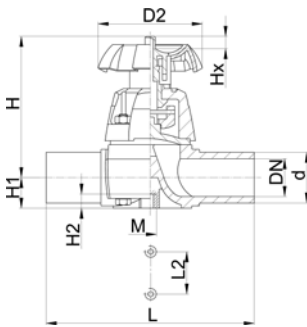

d [mm]	DN [mm]	PN	kv-value ($\Delta p=1$ bar) [l/min]	PTFE with EPDM supp. diaphragm Code	kg	D2 [mm]	H [mm]	H1 [mm]	H2 [mm]	L [mm]	L2 [mm]	M
20	15	10	72	175 315 532	0.360	80	90	14	12	124	25	M6
25	20	10	137	175 315 533	0.560	80	102	18	12	144	25	M6
32	25	10	207	175 315 534	0.804	94	119	21	12	154	25	M6
40	32	10	354	175 315 535	1.025	117	126	26	15	174	45	M8
50	40	10	517	175 315 536	1.480	117	139	33	15	194	45	M8
63	50	10	713	175 315 537	2.581	152	172	39	15	224	45	M8



SYGEF® standard Diaphragm valve type 317 PVDF Flanged connection metric

Model:

- DN 15-65 with backing flange
- DN 80-150 with fixed flange
- Overall length according to EN 558-1
- Diaphragm PTFE with EPDM backing diaphragm (FDA compliant)

Option:

- Handwheel with built-in locking mechanism (standard version is nonlockable)

* DN80 and DN150 fixed flanges metric and Inch ANSI B16.5

d [mm]	DN [mm]	Inch	PN	kv-value ($\Delta p=1$ bar) [l/min]	PTFE with EPDM supp. diaphragm Code	kg
20	15	½	10	72	175 317 432	1.000
25	20	¾	10	137	175 317 433	0.858
32	25	1	10	207	175 317 434	1.000
40	32	1 ½	10	354	175 317 435	2.270
50	40	1 ½	10	517	175 317 436	2.260
63	50	2	10	713	175 317 437	3.700
75	65	2 ½	10	992	175 317 438	5.700
*90	80	3	10	1700	175 317 009	10.700
110	100	4	10	2700	175 317 010	14.890
*160	150	6	7	6033	175 317 012	33.500

d [mm]	D [mm]	D1 [mm]	D2 [mm]	D3 [mm]	H [mm]	H1 [mm]	H2 [mm]	Lift = Hx [mm]	L [mm]	L1 [mm]	L2 [mm]	L3 [mm]	M	AL
20	95	65	80	14	90	14	12	8	130		25		M6	4
25	105	75	80	14	102	18	12	11	150		25		M6	4
32	115	85	94	14	119	21	12	13	160		25		M6	4
40	140	100	117	18	126	26	15	16	180		45		M8	4
50	150	110	117	18	139	33	15	21	200		45		M8	4
63	165	125	152	18	172	39	15	28	230		45		M8	4
75	185	145	152	18	201	46	15	30	290		70		M8	4
*90	200	160	270	18	265	57	23	40	310	35	120		M12	8
110	225	180	270	18	302	68	23	50	350	35	120		M12	8
*160	285	240	400	22	437	108	23	70	480	26	100	200	M12	8

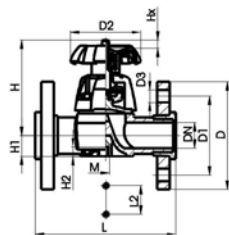

DN 15-65

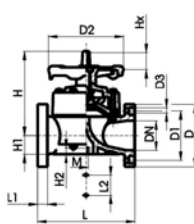

DN 80-100

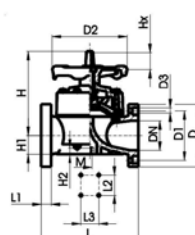

DN 150



SYGEF® standard Diaphragm valve type 317 PVDF Flanged connection ANSI

Model:

- DN 15-65 with backing flange
- DN 80-150 with fixed flange
- Overall length according to EN 558-1
- Diaphragm PTFE with EPDM backing diaphragm (FDA compliant)

Option:

- Handwheel with built-in locking mechanism (standard version is nonlockable)

* DN80 and DN150 fixed flanges metric and Inch ANSI B16.5

d [mm]	DN [mm]	Inch	PN	kv-value ($\Delta p=1$ bar) [l/min]	PTFE with EPDM supp. diaphragm Code	kg
20	15	½	10	72	175 317 532	0.550
25	20	¾	10	137	175 317 533	1.210
32	25	1	10	207	175 317 534	1.210
40	32	1 ¼	10	354	175 317 535	2.270
50	40	1 ½	10	517	175 317 536	2.280
63	50	2	10	713	175 317 537	3.681
75	65	2 ½	10	992	175 317 538	6.000
*90	80	3	10	1700	175 317 339	
*110	100	4	10	2700	175 317 340	14.950
*160	150	6	7	6033	175 317 012	33.500

d [mm]	D [mm]	D1 [mm]	D2 [mm]	D3 [mm]	H [mm]	H1 [mm]	H2 [mm]	Lift = Hx [mm]	L [mm]	L1 [mm]	L2 [mm]	L3 [mm]	M	AL
20	95	61	80	14	90	14	12	8	130		25		M6	4
25	105	70	80	14	93	18	12	11	150		25		M6	4
32	115	80	94	14	119	21	12	13	160		25		M6	4
40	140	89	117	18	126	26	15	16	180		45		M8	4
50	150	99	117	18	139	33	15	21	200		45		M8	4
63	165	121	152	18	172	39	15	28	230		45		M8	4
75	185	140	152	18	201	46	15	30	290		70		M8	4
*90	200	152	270	18	265	57	23	40	310	35	120		M12	8
*110	225	191	270	18	304	69	23	50	350	35	120		M12	8
*160	285	240	400	22	437	108	23	70	480	26	100	200	M12	8

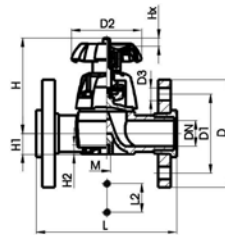

DN 15-65

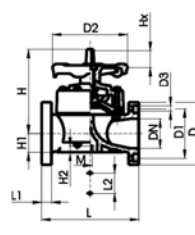

DN 80-100

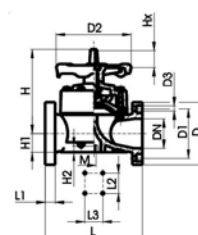

DN 150

Spare parts for diaphragm valve type 314 PVDF

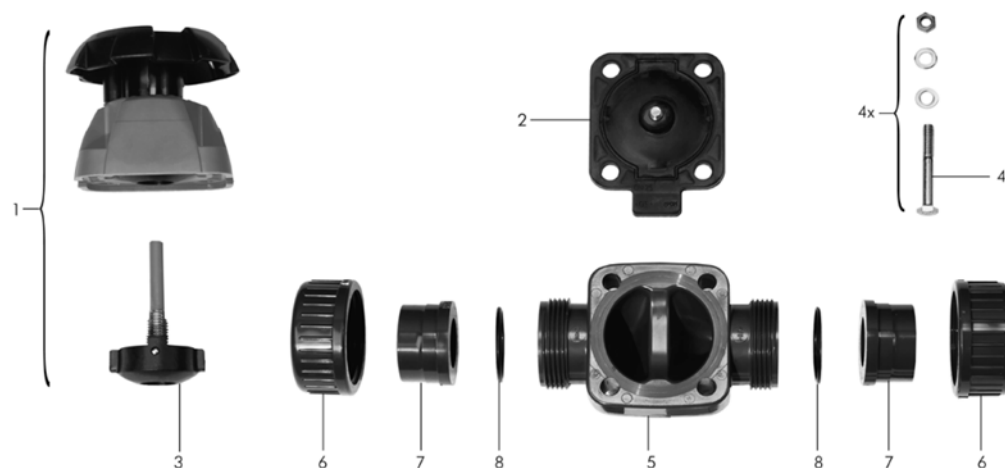

No.	Article / Material	Pieces	d20 DN 15	d25 DN 20	d32 DN 25	d40 DN 32	d50 DN 40	d63 DN 50
1	Bonnet complete (without diaphragm) elastomer diaphragm	1	161 484 625	161 484 626	161 484 627	161 484 628	161 484 629	161 484 630
1	Bonnet complete (without diaphragm) PTFE-diaphragm	1	161 484 632	161 484 633	175 481 860	175 481 861	175 481 862	175 481 863
2	Diaphragm EPDM	1	161 481 022	161 481 023	161 481 024	161 481 025	161 481 026	161 481 027
2	Diaphragm FPM	1	161 481 092	161 481 093	161 481 094	161 481 095	161 481 096	161 481 097
2	Diaphragm PTFE/EPDM	1	161 311 698	161 311 699	161 311 700	161 311 701	161 311 702	161 311 703
2	Diaphragm PTFE/FPM	1	161 481 926	161 481 927	161 481 928	161 481 929	161 481 930	161 481 931
2	Diaphragm PTFE/EPDM SYGEF plus HP	1	161 484 452	161 484 453	161 484 454	161 484 455	161 484 456	161 484 457
3	Pressure spindle PTFE-diaphragm	1	161 484 696	161 484 697	161 484 698	161 484 699	161 484 700	161 484 701
3	Pressure spindle Elastomer diaphragm	1	161 484 688	161 484 689	161 484 690	161 484 691	161 484 692	161 484 693
4	Fastening set Stainless steel	1	161 484 704	161 484 705	161 484 706	161 484 707	161 484 708	161 484 709
5	Valve body PVDF standard	1	175 481 977	175 481 978	175 481 979	175 481 980	175 481 981	175 481 982
6	Union nut PVDF standard	2	735 690 406	735 690 407	735 690 408	735 690 409	735 690 410	735 690 411
7	Fusion socket PVDF standard	2	735 600 106	735 600 107	735 600 108	735 600 109	735 600 110	735 600 111
7	Butt fusion spigot PVDF standard	2	735 608 606	735 608 607	735 608 608	735 608 609	735 608 610	735 608 611
8	O-ring seal EPDM	2	748 410 006	748 410 007	748 410 008	748 410 009	748 410 010	748 410 011
8	O-ring seal FPM	2	749 410 006	749 410 007	749 410 008	749 410 009	749 410 010	749 410 011

Ball valves type 546

SYGEF® standard Ball valve type 546 PVDF With mounting inserts With fusion sockets metric



DN10/15 - 50

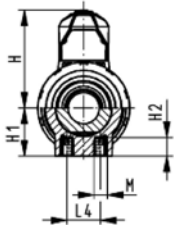
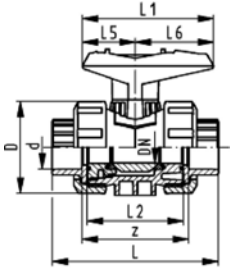

Model:

- For easy installation and removal
- z-dimension, valve end and valve nut are **not compatible** with type 346 (DN10/15-50) resp. type 370 (DN65-100)
- Ball seals PTFE
- Integrated stainless steel mounting inserts

Option:

- Individual configuration of the valve (see form)
- Multifunctional module with integrated limit switches
- Pneumatic or electric actuators from +GF+

d [mm]	DN [mm]	PN	kv-value ($\Delta p=1$ bar) [l/min]	FPM Code	kg
16	10	16	71	175 546 411	0.195
20	15	16	185	175 546 412	0.200
25	20	16	350	175 546 413	0.300
32	25	16	700	175 546 414	0.440
40	32	16	1000	175 546 415	0.760
50	40	16	1600	175 546 416	1.060
63	50	16	3100	175 546 417	2.055

d [mm]	D [mm]	H [mm]	H1 [mm]	H2 [mm]	L [mm]	L1 [mm]	L2 [mm]	L4 [mm]	L5 [mm]	L6 [mm]	M	z [mm]
16	50	79	27	12	93	77	56	25	32	45	M6	67
20	50	57	27	12	95	77	56	25	32	45	M6	66
25	58	67	30	12	109	97	65	25	39	58	M6	77
32	68	73	36	12	119	97	71	25	39	58	M6	83
40	84	90	44	15	135	128	85	45	54	74	M8	99
50	97	97	51	15	147	128	89	45	54	74	M8	105
63	124	116	64	15	168	152	101	45	66	87	M8	117

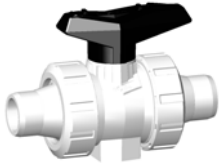

DN10/15 - 50

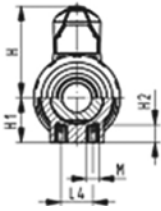
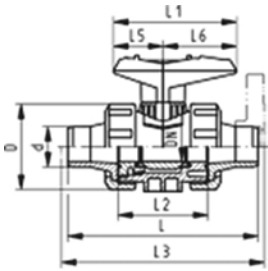

SYGEF® standard Ball valve type 546 PVDF With mounting inserts With socket fusion spigots metric

Model:

- For easy installation and removal
- z-dimension, valve end and valve nut are **not compatible** with type 346 (DN10/15-50) resp. type 370 (DN65-100)
- Ball seals PTFE
- Integrated stainless steel mounting inserts

Option:

- Individual configuration of the valve (see form)
- Multifunctional module with integrated limit switches
- Pneumatic or electric actuators from +GF+

d [mm]	DN [mm]	PN	kv-value ($\Delta p=1$ bar) [l/min]	FPM Code	kg
16	10	16	71	175 546 051	0.200
20	15	16	185	175 546 052	0.205
25	20	16	350	175 546 053	0.310
32	25	16	700	175 546 054	0.460
40	32	16	1000	175 546 055	0.780
50	40	16	1600	175 546 056	1.110
63	50	16	3100	175 546 057	2.150

d [mm]	D [mm]	H [mm]	H1 [mm]	H2 [mm]	L [mm]	L1 [mm]	L2 [mm]	L3 [mm]	L4 [mm]	L5 [mm]	L6 [mm]	M
16	50	57	27	12	110	77	56		25	32	45	M6
20	50	57	27	12	120	77	56	130	25	32	45	M6
25	58	67	30	12	139	97	65	150	25	39	58	M6
32	68	73	36	12	150	97	71	160	25	39	58	M6
40	84	90	44	15	170	128	85	180	45	54	74	M8
50	97	97	51	15	190	128	89	200	45	54	74	M8
63	124	116	64	15	220	152	101	230	45	66	87	M8

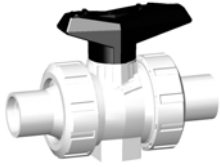

DN10/15 - 50

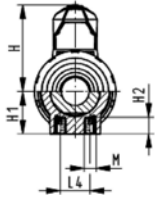
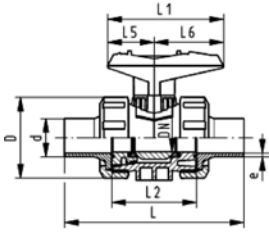

SYGEF® standard Ball valve type 546 PVDF With mounting inserts With butt fusion spigots metric

Model:

- For easy installation and removal
- z-dimension, valve end and valve nut are **not compatible** with type 346 (DN10/15-50) resp. type 370 (DN65-100)
- Ball seals PTFE
- Integrated stainless steel mounting inserts

Option:

- Individual configuration of the valve (see form)
- Multifunctional module with integrated limit switches
- Pneumatic or electric actuators from +GF+

d [mm]	DN [mm]	PN	kv-value ($\Delta p=1$ bar) [l/min]	FPM Code	kg							
20	15	16	185	175 546 272	0.205							
25	20	16	350	175 546 273	0.310							
32	25	16	700	175 546 274	0.460							
40	32	16	1000	175 546 275	0.780							
50	40	16	1600	175 546 276	1.110							
63	50	16	3100	175 546 277	2.150							

d [mm]	D [mm]	H [mm]	H1 [mm]	H2 [mm]	L [mm]	L1 [mm]	L2 [mm]	L4 [mm]	L5 [mm]	L6 [mm]	M	e [mm]		
20	50	57	27	12	130	77	56	25	32	45	M6	1,9		
25	58	67	30	12	143	97	65	25	39	58	M6	1,9		
32	68	73	36	12	150	97	71	25	39	58	M6	2,4		
40	84	90	44	15	171	128	85	45	54	74	M8	2,4		
50	97	97	51	15	191	128	89	45	54	74	M8	3		
63	124	116	64	15	220	152	101	45	66	87	M8	3		

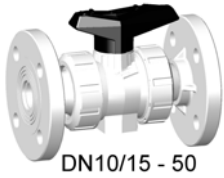

SYGEF® standard
Ball valve type 546 PVDF
With mounting inserts
With fixed flanges PVDF serrated metric

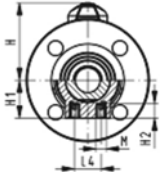
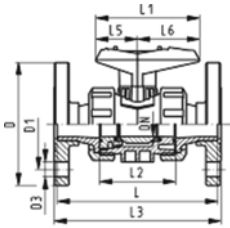

Model:

- For easy installation and removal
- z-dimension, valve end and valve nut are **not compatible** with type 346 (DN10/15-50) resp. type 370 (DN65-100)
- Ball seals PTFE
- Integrated stainless steel mounting inserts
- Overall length EN 558-1

Option:

- Individual configuration of the valve (see form)
- Multifunctional module with integrated limit switches
- Pneumatic or electric actuators from +GF+

d [mm]	DN [mm]	PN	kv-value ($\Delta p=1$ bar) [l/min]	FPM Code	kg
20	15	16	185	175 546 192	0.470
25	20	16	350	175 546 193	0.650
32	25	16	700	175 546 194	0.940
40	32	16	1000	175 546 195	1.570
50	40	16	1600	175 546 196	2.070
63	50	16	3100	175 546 197	3.490

d [mm]	D [mm]	D1 [mm]	D3 [mm]	H [mm]	H1 [mm]	H2 [mm]	L [mm]	L1 [mm]	L2 [mm]	L3 [mm]	L4 [mm]	L5 [mm]	L6 [mm]	M
20	93	65	14	57	27	12	120	77	56	130	25	32	45	M6
25	103	75	14	67	30	12	140	97	65	150	25	39	58	M6
32	115	85	14	73	36	12	150	97	71	160	25	39	58	M6
40	137	100	18	90	44	15	170	128	85	180	45	54	74	M8
50	147	110	18	97	51	15	190	128	89	200	45	54	74	M8
63	162	125	18	116	64	15	220	152	101	230	45	66	87	M8

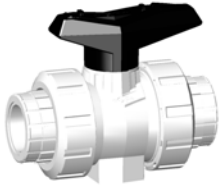

DN10/15 - 50

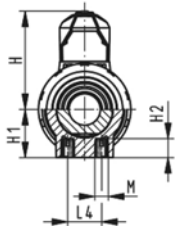
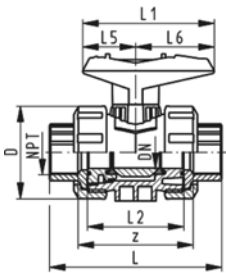

SYGEF® standard Ball valve type 546 PVDF With mounting inserts With threaded sockets NPT

Model:

- For easy installation and removal
- z-dimension, valve end and valve nut are **not compatible** with type 346 (DN10/15-50) resp. type 370 (DN65-100)
- Ball seals PTFE
- Integrated stainless steel mounting inserts

Option:

- Individual configuration of the valve (see form)
- Multifunctional module with integrated limit switches
- Pneumatic or electric actuators from +GF+

NPT [inch]	DN [mm]	PN	kv-value ($\Delta p=1$ bar) [l/min]	FPM Code	kg
3/8	10	10	71	175 546 331	0.205
1/2	15	10	185	175 546 332	0.220
3/4	20	10	350	175 546 333	0.325
1	25	10	700	175 546 334	0.490
1 1/4	32	10	1000	175 546 335	0.820
1 1/2	40	10	1600	175 546 336	1.135
2	50	10	3100	175 546 337	2.150

NPT [inch]	D [mm]	H [mm]	H1 [mm]	H2 [mm]	L [mm]	L1 [mm]	L2 [mm]	L4 [mm]	L5 [mm]	L6 [mm]	M	z [mm]
3/8	50	57	27	12	96	77	56	25	32	45	M6	69
1/2	50	57	27	12	99	77	56	25	32	45	M6	64
3/4	58	67	30	12	111	97	65	25	39	58	M6	76
1	68	73	36	12	127	97	71	25	39	58	M6	83
1 1/4	84	90	44	15	146	128	85	45	54	74	M8	101
1 1/2	97	97	51	15	157	128	89	45	54	74	M8	111
2	124	116	64	15	183	152	101	45	66	87	M8	135

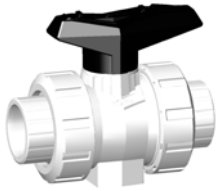

DN10/15 - 50

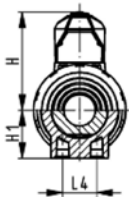
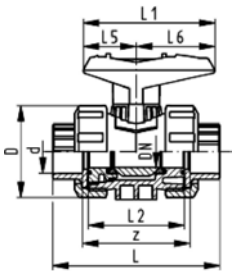

SYGEF® standard Ball valve type 546 PVDF With fusion sockets metric

Model:

- For easy installation and removal
- z-dimension, valve end and valve nut are **not compatible** with type 346 (DN10/15-50) resp. type 370 (DN65-100)
- Ball seals PTFE
- Without mounting inserts

Option:

- Individual configuration of the valve (see form)
- Multifunctional module with integrated limit switches
- Pneumatic or electric actuators from +GF+

d [mm]	DN [mm]	PN	kv-value ($\Delta p=1$ bar) [l/min]	FPM Code	kg
16	10	16	71	175 546 011	0.195
20	15	16	185	175 546 012	0.200
25	20	16	350	175 546 013	0.300
32	25	16	700	175 546 014	0.440
40	32	16	1000	175 546 015	0.760
50	40	16	1600	175 546 016	1.060
63	50	16	3100	175 546 017	2.055

d [mm]	D [mm]	H [mm]	H1 [mm]	L [mm]	L1 [mm]	L2 [mm]	L4 [mm]	L5 [mm]	L6 [mm]	z [mm]
16	50	57	27	93	77	56	25	32	45	67
20	50	57	27	95	77	56	25	32	45	66
25	58	67	30	109	97	65	25	39	58	77
32	68	73	36	119	97	71	25	39	58	83
40	84	90	44	135	128	85	45	54	74	99
50	97	97	51	147	128	89	45	54	74	105
63	124	116	64	168	152	101	45	66	87	117

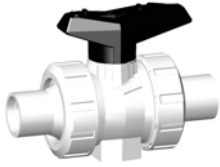

DN10/15 - 50

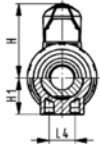
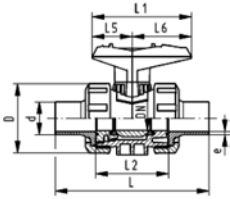

SYGEF® standard Ball valve type 546 PVDF With butt fusion spigots metric

Model:

- For easy installation and removal
- z-dimension, valve end and valve nut are **not compatible** with type 346 (DN10/15-50) resp. type 370 (DN65-100)
- Ball seals PTFE
- Without mounting inserts

Option:

- Individual configuration of the valve (see form)
- Multifunctional module with integrated limit switches
- Pneumatic or electric actuators from +GF+

d [mm]	DN [mm]	PN	kv-value ($\Delta p=1$ bar) [l/min]	FPM Code	kg
20	15	16	185	175 546 092	0.205
25	20	16	350	175 546 093	0.310
32	25	16	700	175 546 094	0.460
40	32	16	1000	175 546 095	0.780
50	40	16	1600	175 546 096	1.110
63	50	16	3100	175 546 097	2.150

d [mm]	D [mm]	H [mm]	H1 [mm]	L [mm]	L1 [mm]	L2 [mm]	L4 [mm]	L5 [mm]	L6 [mm]	e [mm]
20	50	57	27	130	77	56	25	32	45	1,9
25	58	67	30	143	97	65	25	39	58	1,9
32	68	73	36	150	97	71	25	39	58	2,4
40	84	90	44	171	128	85	45	54	74	2,4
50	97	97	51	191	128	89	45	54	74	3
63	124	116	64	220	152	101	45	66	87	3



DN10/15 - 50

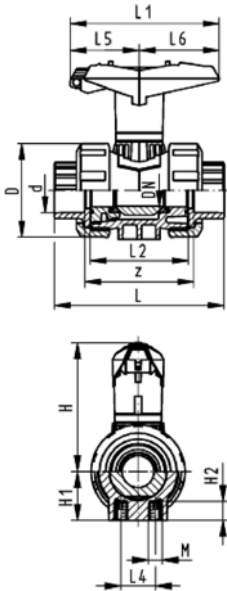

SYGEF® standard Ball valve type 546 PVDF With lockable handle With fusion sockets metric

Model:

- For easy installation and removal
- z-dimension, valve end and valve nut are **not compatible** with type 346 (DN10/15-50) resp. type 370 (DN65-100)
- Ball seals PTFE
- Integrated stainless steel mounting inserts
- Lockable hand lever with ratchet settings

Option:

- Individual configuration of the valve (see form)
- Multifunctional module with integrated limit switches
- Pneumatic or electric actuators from +GF+

d [mm]	DN [mm]	PN	kv-value ($\Delta p=1$ bar) [l/min]	FPM Code	kg
16	10	16	71	175 546 431	0.205
20	15	16	185	175 546 432	0.210
25	20	16	350	175 546 433	0.315
32	25	16	700	175 546 434	0.455
40	32	16	1000	175 546 435	0.785
50	40	16	1600	175 546 436	1.085
63	50	16	3100	175 546 437	2.085

d [mm]	D [mm]	H [mm]	H1 [mm]	H2 [mm]	L [mm]	L1 [mm]	L2 [mm]	L4 [mm]	L5 [mm]	L6 [mm]	M	z [mm]
16	50	79	27	12	93	77	56	25	32	45	M6	67
20	50	79	27	12	95	77	56	25	32	45	M6	66
25	58	88	30	12	109	97	65	25	39	58	M6	77
32	68	94	36	12	119	97	71	25	39	58	M6	83
40	84	113	44	15	135	128	85	45	54	74	M8	99
50	97	119	51	15	147	128	89	45	54	74	M8	105
63	124	141	64	15	168	152	101	45	66	87	M8	117

Ball valves silicon free/paint compatible

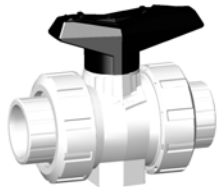

DN10/15 - 50

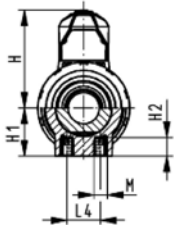
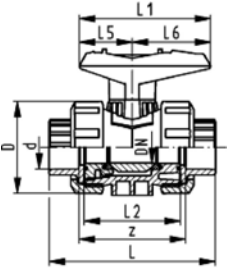

SYGEF® standard silicone free Ball valve type 546 SF With fusion sockets metric

Model:

- Silicon-free / paint-compatible
- Ball seals PVDF
- For easy installation and removal
- z-dimension, valve end and valve nut are **not compatible** with type 346 (DN10/15-50) resp. type 370 (DN65-100)
- Integrated stainless steel mounting inserts

Option:

- Individual configuration of the valve (see form)
- Multifunctional module with integrated limit switches
- Pneumatic or electric actuators from +GF+

d [mm]	DN [mm]	PN	kv-value ($\Delta p=1$ bar) [l/min]	FPM Code	kg
16	10	16	71	175 546 691	0.195
20	15	16	185	175 546 692	0.200
25	20	16	350	175 546 693	0.300
32	25	16	700	175 546 694	0.440
40	32	16	1000	175 546 695	0.760
50	40	16	1600	175 546 696	1.060
63	50	16	3100	175 546 697	2.055

d [mm]	D [mm]	H [mm]	H1 [mm]	H2 [mm]	L [mm]	L1 [mm]	L2 [mm]	L4 [mm]	L5 [mm]	L6 [mm]	M	z [mm]
16	50	79	27	12	93	77	56	25	32	45	M6	67
20	50	57	27	12	95	77	56	25	32	45	M6	66
25	58	67	30	12	109	97	65	25	39	58	M6	77
32	68	73	36	12	119	97	71	25	39	58	M6	83
40	84	90	44	15	135	128	85	45	54	74	M8	99
50	97	97	51	15	147	128	89	45	54	74	M8	105
63	124	116	64	15	168	152	101	45	66	87	M8	117



DN10/15 - 50

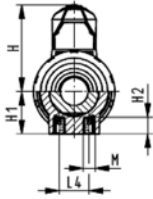
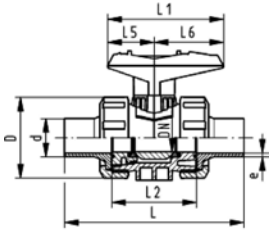

SYGEF[®] standard silicone free Ball valve type 546 SF With butt fusion spigots IR-Plus metric

Model:

- Silicon-free / paint-compatible
- Ball seals PVDF
- For easy installation and removal
- z-dimension, valve end and valve nut are **not compatible** with type 346 (DN10/15-50) resp. type 370 (DN65-100)
- Integrated stainless steel mounting inserts

Option:

- Individual configuration of the valve (see form)
- Multifunctional module with integrated limit switches
- Pneumatic or electric actuators from +GF+

d [mm]	DN [mm]	PN	kv-value ($\Delta p=1$ bar) [l/min]	FPM Code	kg
20	15	16	185	175 546 752	0.205
25	20	16	350	175 546 753	0.310
32	25	16	700	175 546 754	0.460
40	32	16	1000	175 546 755	0.780
50	40	16	1600	175 546 756	1.110
63	50	16	3100	175 546 757	2.150

d [mm]	D [mm]	H [mm]	H1 [mm]	H2 [mm]	L [mm]	L1 [mm]	L2 [mm]	L4 [mm]	L5 [mm]	L6 [mm]	M	e [mm]
20	50	57	27	12	130	77	56	25	32	45	M6	1,9
25	58	67	30	12	143	97	65	25	39	58	M6	1,9
32	68	73	36	12	150	97	71	25	39	58	M6	2,4
40	84	90	44	15	171	128	85	45	54	74	M8	2,4
50	97	97	51	15	191	128	89	45	54	74	M8	3
63	124	116	64	15	220	152	101	45	66	87	M8	3

Spare Parts Ball Valves 546

Multifunctional module (I02) PP-GF Module empty



DN10/15 - 50

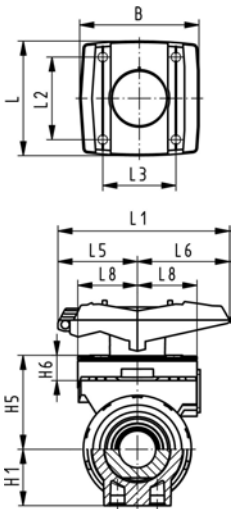

Model:

- Accessory to Ball Valve Type 546
- Multifunctional module acts as an intermediate element for actuators
- Including screws to mount the module and stainless steel coupling piece (V2A) for dimension DN65-100

d-d [mm]	DN-DN [mm]	Code	kg
16 - 20	10 - 15	167 482 680	0.055
25 - 32	20 - 25	167 482 681	0.070
40 - 50	32 - 40	167 482 682	0.080
- 63	- 50	167 482 683	0.120

d-d [mm]	B [mm]	H1 [mm]	H5 [mm]	H6 [mm]	L [mm]	L1 [mm]	L2 [mm]	L3 [mm]	L5 [mm]	L6 [mm]	L8 [mm]
16 - 20	67	27	50	17	72	87	54	40	42	45	34
25 - 32	75	30	53	16	72	108	52	46	50	58	38
40 - 50	81	44	72	16	80	140	60	50	66	75	41
- 63	91	64	94	19	93	165	68	65	78	87	46



DN10/15 - 50

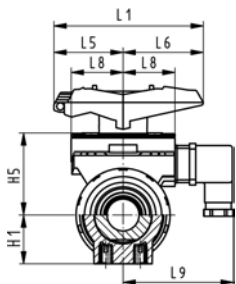
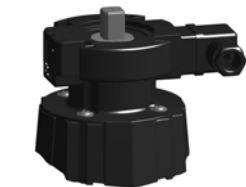

Multifunctional module (I03) PP-GF With mechanical limit switches Ag Ni

Model:

- Accessory to Ball Valve Type 546
- Multifunctional module acts as an intermediate element for actuators
- Including Plug 3P+E / Protection: IP65
- Including screws to mount the module and stainless steel coupling piece (V2A) for dimension DN65-100

d-d [mm]	DN-DN [mm]	Code	kg	H1 [mm]	H5 [mm]	L1 [mm]	L5 [mm]	L6 [mm]	L8 [mm]	L9 [mm]
16 - 20	10 - 15	167 482 626	0.110	27	50	87	42	45	34	73
25 - 32	20 - 25	167 482 627	0.120	30	53	108	50	58	38	77
40 - 50	32 - 40	167 482 628	0.135	44	72	140	66	75	41	80
- 63	- 50	167 482 629	0.175	64	94	165	78	87	46	85

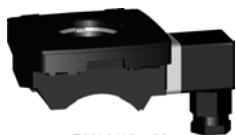

DN10/15 - 50

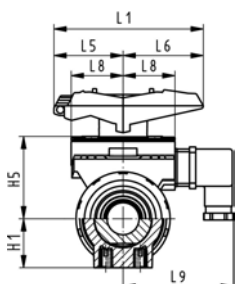

Multifunctional module (I04) PP-GF With mechanical limit switches Au

Model:

- Accessory to Ball Valve Type 546
- Multifunctional module acts as an intermediate element for actuators
- Including Plug 3P+E / Protection: IP65
- Including screws to mount the module and stainless steel coupling piece (V2A) for dimension DN65-100

d-d [mm]	DN-DN [mm]	Code	kg	H1 [mm]	H5 [mm]	L1 [mm]	L5 [mm]	L6 [mm]	L8 [mm]	L9 [mm]
16 - 20	10 - 15	167 482 635	0.110	27	50	87	42	45	34	73
25 - 32	20 - 25	167 482 636	0.120	30	53	108	50	58	38	77
40 - 50	32 - 40	167 482 637	0.135	44	72	140	66	75	41	80
- 63	- 50	167 482 638	0.175	64	94	165	78	87	46	85

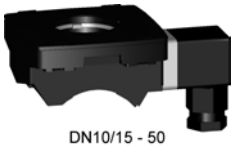

DN10/15 - 50

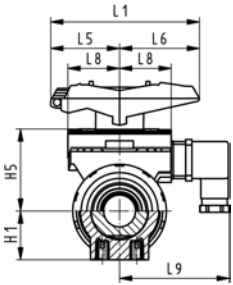

Multifunctional module (I05) PP-GF With inductive limit switches Namur

Model:

- Accessory to Ball Valve Type 546
- Multifunctional module acts as an intermediate element for actuators
- Including Plug 3P+E / Protection: IP65
- Including screws to mount the module and stainless steel coupling piece (V2A) for dimension DN65-100

d-d [mm]	DN-DN [mm]	Code	kg	H1 [mm]	H5 [mm]	L1 [mm]	L5 [mm]	L6 [mm]	L8 [mm]	L9 [mm]
16 - 20	10 - 15	167 482 671	0.110	27	50	87	42	45	34	73
25 - 32	20 - 25	167 482 672	0.120	30	53	108	50	58	38	77
40 - 50	32 - 40	167 482 673	0.135	44	72	140	66	75	41	80
- 63	- 50	167 482 674	0.175	64	94	165	78	87	46	85



DN10/15 - 50

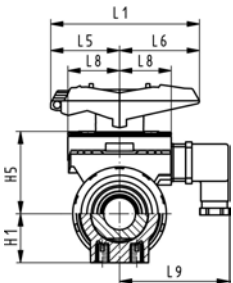

Multifunctional module (I06) PP-GF With inductive limit switches PNP

Model:

- Accessory to Ball Valve Type 546
- Multifunctional module acts as an intermediate element for actuators
- Including Plug 3P+E / Protection: IP65
- Including screws to mount the module and stainless steel coupling piece (V2A) for dimension DN65-100

d-d [mm]	DN-DN [mm]	Code	kg	H1 [mm]	H5 [mm]	L1 [mm]	L5 [mm]	L6 [mm]	L8 [mm]	L9 [mm]
16 - 20	10 - 15	167 482 662	0.110	27	50	87	42	45	34	73
25 - 32	20 - 25	167 482 663	0.120	30	53	108	50	58	38	77
40 - 50	32 - 40	167 482 664	0.135	44	72	140	66	75	41	80
- 63	- 50	167 482 665	0.175	64	94	165	78	87	46	85



DN10/15 - 50

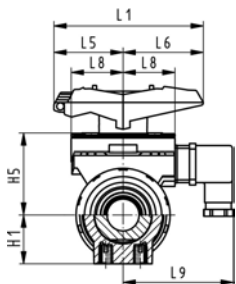

Multifunctional module (I07) PP-GF With inductive limit switches NPN

Model:

- Accessory to Ball Valve Type 546
- Multifunctional module acts as an intermediate element for actuators
- Including Plug 3P+E / Protection: IP65
- Including screws to mount the module and stainless steel coupling piece (V2A) for dimension DN65-100

d-d [mm]	DN-DN [mm]	Code	kg	H1 [mm]	H5 [mm]	L1 [mm]	L5 [mm]	L6 [mm]	L8 [mm]	L9 [mm]
16 - 20	10 - 15	167 482 653	0.110	27	50	87	42	45	34	73
25 - 32	20 - 25	167 482 654	0.120	30	53	108	50	58	38	77
40 - 50	32 - 40	167 482 655	0.135	44	72	140	66	75	41	80
- 63	- 50	167 482 656	0.175	64	94	165	78	87	46	85

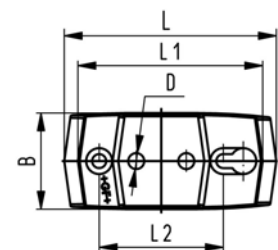
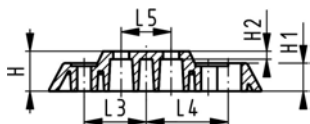

Mounting plate 546 PP-GF (L02)

- 2 mounting screws inclusive

d-d [mm]	DN-DN [mm]	Code	kg
16 - 32	10 - 25	167 484 110	0.055
40 - 63	32 - 50	167 484 111	0.086

d-d [mm]	B [mm]	D [mm]	H [mm]	H1 [mm]	H2 [mm]	L [mm]	L1 [mm]	L2 [mm]	L3 [mm]	L4 [mm]	L5 [mm]
16 - 32	48	8	20	14	4	106	92	62	31	41	25
40 - 63	54	9	20	14	4	149	134	104	52	62	45

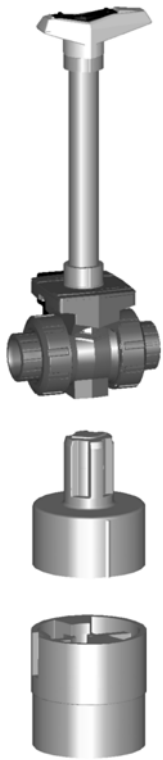

Handle extension 546 PVC-U metric

Model:

- For Ball Valve Type 546
- Composed of adapter sockets for handle connection and stem connection
- PVC-U pipe in suitable length has to be obtained on site

d-d [mm]	DN-DN [mm]	Code	kg	H [mm]	H1 [mm]	H2 [mm]	H3 [mm]	D [mm]
16 - 20	10 - 15	161 486 435	0.032	41	52	29	36	26
25 - 32	20 - 25	161 486 436	0.037	50	62	32	39	36
40 - 50	32 - 40	161 486 437	0.047	65	76	34	44	40
- 63	- 50	161 486 438	0.058	84	87	37	48	44

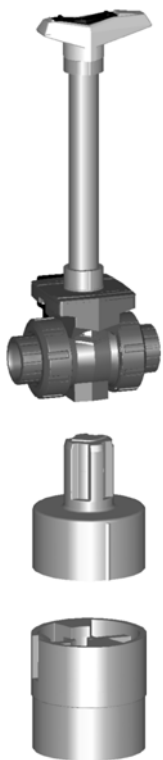
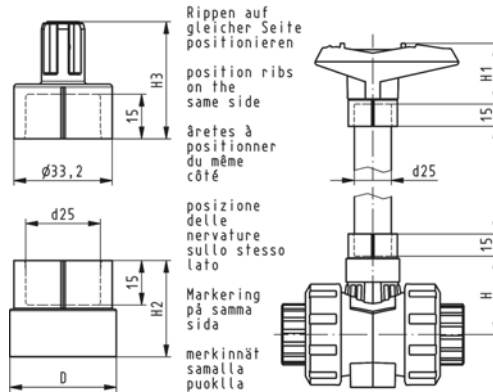

Handle extension 546 PVC-U inch BS/ASTM

- For Ball Valve Type 546

DN-DN [mm]	Inch	Code	kg	H [mm]	H1 [mm]	H2 [mm]	H3 [mm]	D [mm]
10 - 15	3/8-1/2	161 486 443	0.032	41	52	29	36	26
20 - 25	3/4-1	161 486 444	0.037	50	62	32	39	36
32 - 40	1 1/4-1 1/2	161 486 445	0.047	65	76	34	44	40
50 -	2	161 486 446	0.058	84	87	37	48	44

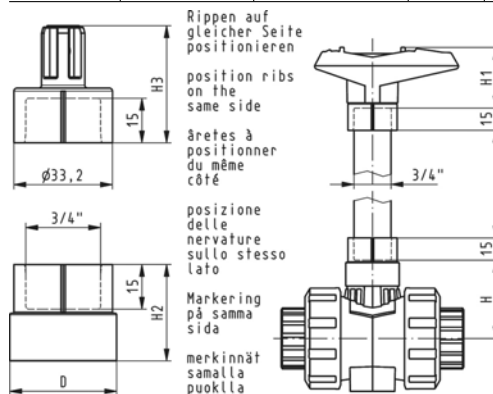

Spare parts for ball valve type 546 PVDF

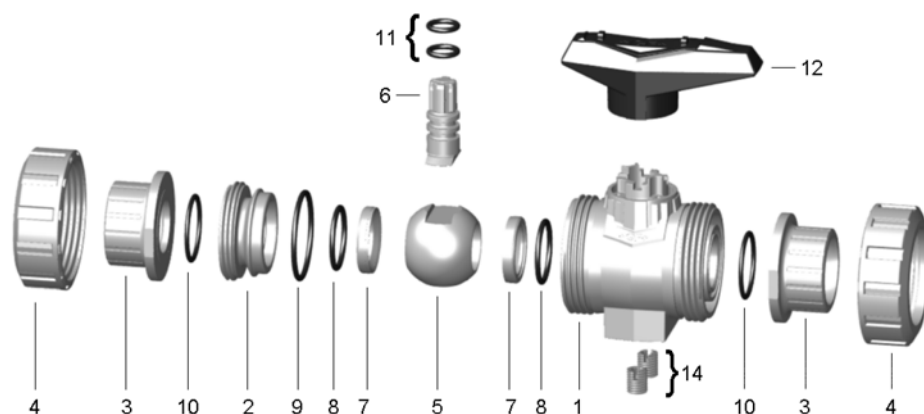

No.	Article / Material	Pieces	d16 DN10	d20 DN15	d25 DN20	d32 DN25	d40 DN32	d50 DN40	d63 DN50
1	Central part Body PVDF	1	175 482 963	175 482 963	175 482 964	175 482 965	175 482 966	175 482 967	175 482 968
2	Union bush PVDF	1							
5	Ball PVDF	1							
6	Stem PVDF	1							
7	Ball seal PTFE	2							
8	Backing seal FPM	2							
9	Body seal FPM	1							
10	Face seal FPM	2							
11	Stem seal FPM	2							
12	Lever PP black	1							
14	Threaded bush Stainless steel	2							
5	Ball set Ball PVDF	1	175 483 275	175 483 275	175 483 276	175 483 277	175 483 278	175 483 279	175 483 280
6	Stem PVDF	1							
7	Ball seal PTFE	2							
8	Backing seal FPM	2							
9	Body seal FPM	1							
11	Stem seal FPM	2							
8	Seal set Backing seal FPM	2	161 486 410	161 486 410	161 486 411	161 486 412	161 486 413	161 486 414	161 486 415
9	Body seal FPM	1							
10	Face seal FPM	2							
11	Stem seal FPM	2							
3	Connecting piece 546 PVDF (G50) with fusion socket metric	1	175 483 025	175 483 026	175 483 027	175 483 028	175 483 029	175 483 030	175 483 031
3	Connecting piece 546 PVDF (G51) with socket fusion spigot metric	1	175 483 036	175 483 037	175 483 038	175 483 039	175 483 040	175 483 041	175 483 042
3	Connecting piece 546 PVDF (G52) with butt fusion spigot IR-Plus® metric	1	-	175 483 048	175 483 049	175 483 050	175 483 051	175 483 052	175 483 053

No.	Article / Material	Pieces	d16 DN10	d20 DN15	d25 DN20	d32 DN25	d40 DN32	d50 DN40	d63 DN50
3	Connecting piece 546 PVDF (G53) with threaded socket NPT	1	175 483 058	175 483 059	175 483 060	175 483 061	175 483 062	175 483 063	175 483 064
3	Connecting piece 546 PVDF (G64) subassembly with fixed flange serrated PVDF metric	1	-	175 483 285	175 483 286	175 483 287	175 483 288	175 483 289	175 483 290
4	Union nut 546 PVDF	1	175 482 937	175 482 937	175 482 938	175 482 939	175 482 940	175 482 941	175 482 942
12	Standard handle 546 red (K01)	1	167 484 088	167 484 088	167 484 089	167 484 090	167 484 091	167 484 092	167 484 093
12	Standard handle 546 black (K02)	1	167 484 076	167 484 076	167 484 077	167 484 078	167 484 079	167 484 080	167 484 081
22	Multifunction handle 546 red (K11) with ratchet settings lockable	1	167 484 100	167 484 100	167 484 101	167 484 102	167 484 103	167 484 104	167 484 105
10	Face seal FPM	1	749 470 059	749 470 059	749 470 106	749 470 151	749 470 062	749 470 003	749 470 231

Ball valves type 343

SYGEF® standard 3-Way ball valve type 343 PVDF Horizontal/L-port With fusion sockets metric

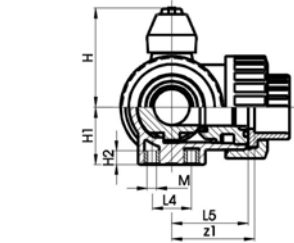
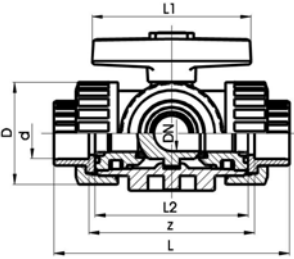
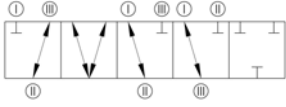

Model:

- L-port ball
- For easy installation and removal
- Ball seals PTFE
- Pneumatic or electric actuator available separately
- Angle of operation 360°, without turn limiter

d [mm]	DN [mm]	PN	kv-value ($\Delta p=1$ bar) [l/min]	FPM Code	kg
16	10	10	49	175 343 011	0.245
20	15	10	77	175 343 012	0.245
25	20	10	146	175 343 013	0.462
32	25	10	260	175 343 014	0.630
40	32	10	437	175 343 015	1.053
50	40	10	667	175 343 016	1.709
63	50	10	1293	175 343 017	3.310

d [mm]	z [mm]	z1 [mm]	D [mm]	H [mm]	H1 [mm]	H2 [mm]	L [mm]	L1 [mm]	L2 [mm]	L4 [mm]	L5 [mm]	M
16	78	39	46	50	27	8	108	78	70	25	36	M6
20	79	40	46	50	27	8	111	78	70	25	36	M6
25	95	48	56	60	33	8	131	92	86	25	43	M6
32	108	54	67	68	36	8	148	100	96	25	48	M6
40	133	67	82	79	44	9	177	110	114	45	58	M8
50	155	78	98	90	49	9	205	120	137	45	69	M8
63	203	102	121	109	61	9	261	146	179	45	90	M8



SYGEF® standard
3-Way ball valve type 343 PVDF
Horizontal/L-port
With fusion spigots metric

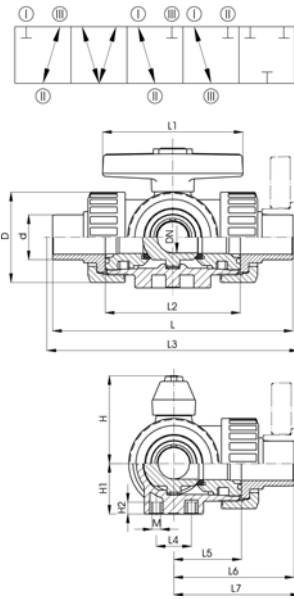

Model:

- L-port ball
- For easy installation and removal
- Ball seals PTFE
- Pneumatic or electric actuator available separately
- Angle of operation 360°, without turn limiter

d [mm]	DN [mm]	PN	kv-value ($\Delta p=1$ bar) [l/min]	FPM Code	kg
16	10	10	49	175 343 031	0.245
20	15	10	77	175 343 032	0.245
25	20	10	146	175 343 033	0.462
32	25	10	260	175 343 034	0.630
40	32	10	437	175 343 035	1.053
50	40	10	667	175 343 036	1.709
63	50	10	1293	175 343 037	3.310

d [mm]	D [mm]	H [mm]	H1 [mm]	H2 [mm]	L [mm]	L1 [mm]	L2 [mm]	L3 [mm]	L4 [mm]	L5 [mm]	L6 [mm]	L7 [mm]	M
16	46	50	27	8	119	78	70	130	25	36	60	65	M6
20	46	50	27	8	133	78	70	144	25	36	67	68	M6
25	56	60	33	8	155	92	86	165	25	43	78	79	M6
32	67	68	36	8	170	100	96	180	25	48	85	87	M6
40	82	79	44	9	201	110	114	209	45	58	101	102	M8
50	98	90	49	9	236	120	137	244	45	69	118	120	M8
63	121	109	61	9	286	146	179	295	45	90	143	150	M8



SYGEF® standard
3-Way ball valve type 343 PVDF
Horizontal/L-port
With butt fusion spigots metric

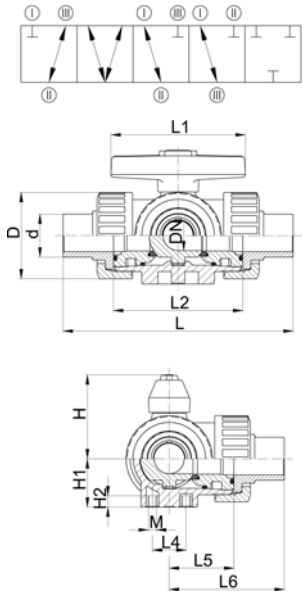

Model:

- L-port ball
- For easy installation and removal
- Ball seals PTFE
- Pneumatic or electric actuator available separately
- Angle of operation 360°, without turn limiter

d [mm]	DN [mm]	PN	kv-value ($\Delta p=1$ bar) [l/min]	FPM Code	kg
16	10	10	49	175 343 051	0.245
20	15	10	77	175 343 052	0.245
25	20	10	146	175 343 053	0.462
32	25	10	260	175 343 054	0.630
40	32	10	437	175 343 055	1.053
50	40	10	667	175 343 056	1.709
63	50	10	1293	175 343 057	3.310

d [mm]	D [mm]	H [mm]	H1 [mm]	H2 [mm]	L [mm]	L1 [mm]	L2 [mm]	L4 [mm]	L5 [mm]	L6 [mm]	M
16	46	50	27	8	119	78	70	25	36	60	M6
20	46	50	27	8	140	78	70	25	36	70	M6
25	56	60	33	8	156	92	86	25	43	78	M6
32	67	68	36	8	168	100	96	25	48	84	M6
40	82	79	44	9	198	110	114	45	58	99	M8
50	98	90	49	9	233	120	137	45	69	117	M8
63	121	109	61	9	285	146	179	45	90	143	M8



SYGEF® standard
3-Way ball valve type 343 PVDF
Horizontal/L-port
With threaded sockets NPT

Model:

- L-port ball
- For easy installation and removal
- Ball seals PTFE
- Pneumatic or electric actuator available separately
- Angle of operation 360°, without turn limiter

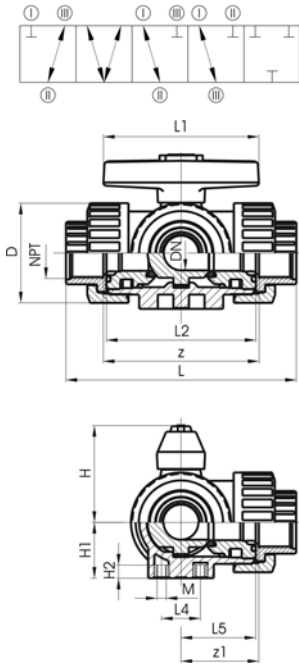

NPT [inch]	DN [mm]	PN	kv-value ($\Delta p=1$ bar) [l/min]	FPM Code	kg
3/8	10	10	49	175 343 071	0.245
1/2	15	10	77	175 343 072	0.245
3/4	20	10	146	175 343 073	0.462
1	25	10	260	175 343 074	0.630
1 1/4	32	10	437	175 343 075	1.053
1 1/2	40	10	667	175 343 076	1.709
2	50	10	1293	175 343 077	3.310

NPT [inch]	z [mm]	z1 [mm]	D [mm]	H [mm]	H1 [mm]	H2 [mm]	L [mm]	L1 [mm]	L2 [mm]	L4 [mm]	L5 [mm]	M
3/8	76	38	46	50	27	8	108	78	70	25	36	M6
1/2	76	38	46	50	27	8	111	78	70	25	36	M6
3/4	90	45	56	60	33	8	131	92	86	25	43	M6
1	100	50	67	68	36	8	148	100	96	25	48	M6
1 1/4	122	61	82	79	44	9	176	110	114	45	58	M8
1 1/2	152	76	98	90	49	9	206	120	137	45	69	M8
2	200	100	116	109	61	9	262	146	179	45	90	M8



SYGEF® standard
3-Way ball valve type 343 PVDF
Horizontal/T-port
With fusion sockets metric

Model:

- T-port ball
- For easy installation and removal
- Ball seals PTFE
- Pneumatic or electric actuator available separately
- Angle of operation 90°, without turn limiter

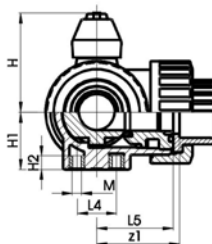
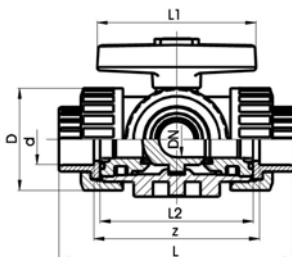
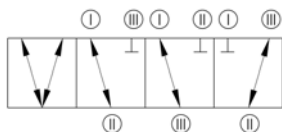

d [mm]	DN [mm]	PN	kv-value ($\Delta p=1$ bar) [l/min]	FPM Code	kg
16	10	10	140	175 343 111	0.245
20	15	10	200	175 343 112	0.245
25	20	10	470	175 343 113	0.462
32	25	10	793	175 343 114	0.630
40	32	10	1290	175 343 115	1.053
50	40	10	1910	175 343 116	1.709
63	50	10	3100	175 343 117	3.310

d [mm]	z [mm]	z1 [mm]	D [mm]	H [mm]	H1 [mm]	H2 [mm]	L [mm]	L1 [mm]	L2 [mm]	L4 [mm]	L5 [mm]	M
16	78	39	46	50	27	8	108	78	70	25	36	M6
20	79	40	46	50	27	8	111	78	70	25	36	M6
25	95	48	56	60	33	8	131	92	86	25	43	M6
32	108	54	67	68	36	8	148	100	96	25	48	M6
40	133	67	82	79	44	9	177	110	114	45	58	M8
50	155	78	98	90	49	9	205	120	137	45	69	M8
63	203	102	121	109	61	9	261	146	179	45	90	M8



SYGEF® standard
3-Way ball valve type 343 PVDF
Horizontal/T-port
With fusion spigots metric

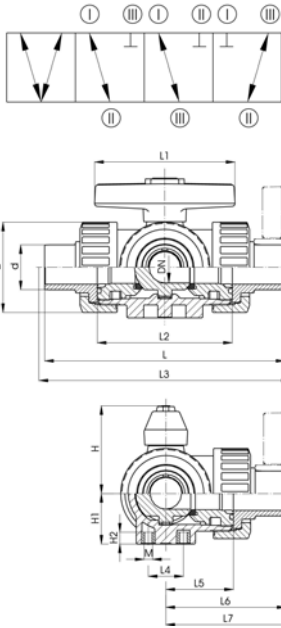

Model:

- T-port ball
- For easy installation and removal
- Ball seals PTFE
- Pneumatic or electric actuator available separately
- Angle of operation 90°, without turn limiter

d [mm]	DN [mm]	PN	kv-value ($\Delta p=1$ bar) [l/min]	FPM Code	kg
16	10	10	140	175 343 131	0.245
20	15	10	200	175 343 132	0.245
25	20	10	470	175 343 133	0.462
32	25	10	793	175 343 134	0.630
40	32	10	1290	175 343 135	1.053
50	40	10	1910	175 343 136	1.709
63	50	10	3100	175 343 137	3.310

d [mm]	D [mm]	H [mm]	H1 [mm]	H2 [mm]	L [mm]	L1 [mm]	L2 [mm]	L3 [mm]	L4 [mm]	L5 [mm]	L6 [mm]	L7 [mm]	M
16	46	50	27	8	119	78	70	130	25	36	60	65	M6
20	46	50	27	8	133	78	70	144	25	36	67	68	M6
25	56	60	33	8	155	92	86	165	25	43	78	79	M6
32	67	68	36	8	170	100	96	180	25	48	85	87	M6
40	82	79	44	9	201	110	114	209	45	58	101	102	M8
50	98	90	49	9	236	120	137	244	45	69	118	120	M8
63	121	109	61	9	286	146	179	295	45	90	143	150	M8



SYGEF® standard 3-Way ball valve type 343 PVDF Horizontal/T-port With butt fusion spigots metric

Model:

- T-port ball
- For easy installation and removal
- Ball seals PTFE
- Pneumatic or electric actuator available separately
- Angle of operation 90°, without turn limiter

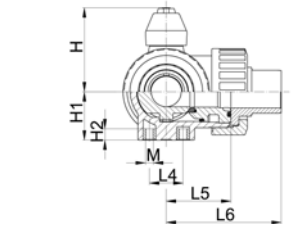
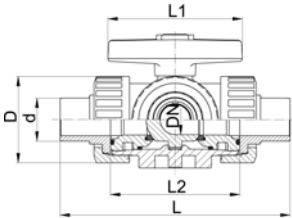
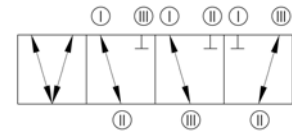

d [mm]	DN [mm]	PN	kv-value ($\Delta p=1$ bar) [l/min]	FPM Code	kg
16	10	10	140	175 343 151	0.245
20	15	10	200	175 343 152	0.245
25	20	10	470	175 343 153	0.462
32	25	10	793	175 343 154	0.630
40	32	10	1290	175 343 155	1.053
50	40	10	1910	175 343 156	1.709
63	50	10	3100	175 343 157	3.310

d [mm]	D [mm]	H [mm]	H1 [mm]	H2 [mm]	L [mm]	L1 [mm]	L2 [mm]	L4 [mm]	L5 [mm]	L6 [mm]	M
16	46	50	27	8	119	78	70	25	36	60	M6
20	46	50	27	8	140	78	70	25	36	70	M6
25	56	60	33	8	156	92	86	25	43	78	M6
32	67	68	36	8	168	100	96	25	48	84	M6
40	82	79	44	9	198	110	114	45	58	99	M8
50	98	90	49	9	233	120	137	45	69	117	M8
63	121	109	61	9	285	146	179	45	90	143	M8



SYGEF® standard 3-Way ball valve type 343 PVDF Horizontal/T-port With threaded sockets NPT

Model:

- T-port ball
- For easy installation and removal
- Ball seals PTFE
- Pneumatic or electric actuator available separately
- Angle of operation 90°, without turn limiter

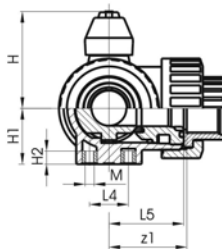
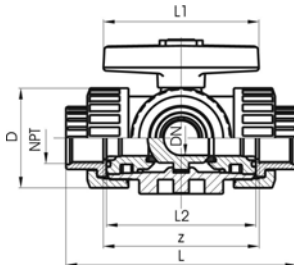
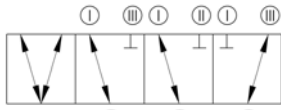

NPT [inch]	DN [mm]	PN	kv-value ($\Delta p=1$ bar) [l/min]	FPM Code	kg
3/8	10	10	140	175 343 171	0.245
1/2	15	10	200	175 343 172	0.245
3/4	20	10	470	175 343 173	0.462
1	25	10	793	175 343 174	0.630
1 1/4	32	10	1290	175 343 175	1.053
1 1/2	40	10	1910	175 343 176	1.709
2	50	10	3100	175 343 177	3.310

NPT [inch]	z [mm]	z1 [mm]	D [mm]	H [mm]	H1 [mm]	H2 [mm]	L [mm]	L1 [mm]	L2 [mm]	L4 [mm]	L5 [mm]	M
3/8	76	38	46	50	27	8	108	78	70	25	36	M6
1/2	76	38	46	50	27	8	111	78	70	25	36	M6
3/4	90	45	56	60	33	8	131	92	86	25	43	M6
1	100	50	67	68	36	8	148	100	96	25	48	M6
1 1/4	122	61	82	79	44	9	176	110	114	45	58	M8
1 1/2	152	76	98	90	49	9	206	120	137	45	69	M8
2	200	100	121	109	61	9	262	146	179	45	90	M8

Spare parts for ball valve type 343 PVDF

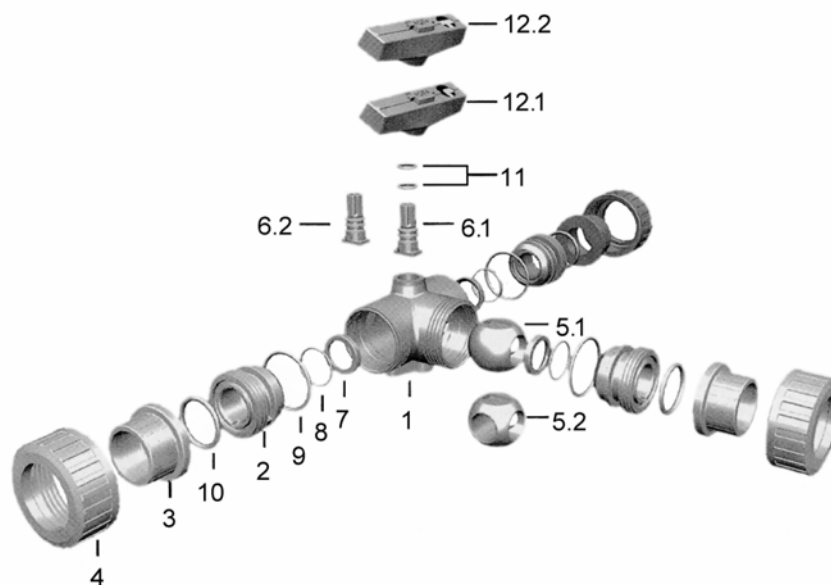

No.	Article / Material	Pieces	d16 DN10	d20 DN15	d25 DN20	d32 DN25	d40 DN32	d50 DN40	d63 DN50
	Central part set L-port		175 482 593	175 482 593	175 482 594	175 482 595	175 482 596	175 482 597	175 482 598
1	Body PVDF	1							
5.1	L-port ball PVDF	1							
7	Ball PTFE	3							
8	Backing seal FPM	3							
9	Body seal FPM	3							
2	Union bush PVDF	3							
6.1	Stem PVDF	1							
11	Stem seal FPM	2							
12.1	Lever ASA	1							
	Central part set T-port		175 482 620	175 482 620	175 482 621	175 482 622	175 482 623	175 482 624	175 482 625
1	Body PVDF	1							
5.2	T-port ball PVDF	1							
7	Ball seal PTFE	3							
8	Backing seal FPM	3							
9	Body seal FPM	3							
2	Union bush PVDF	3							
6.2	Stem PVDF	1							
11	Stem seal FPM	2							
12.2	Lever ASA	1							
	Ball set L-port		175 482 662	175 482 662	175 482 663	175 482 664	175 482 665	175 482 666	175 482 667
5.1	L-port ball PVDF	1							
7	Ball seal FPM	3							
6	Stem PVDF	1							
11	Stem seal FPM	2							
12.1	Lever ASA	1							

No.	Article / Material	Pieces	d16 DN10	d20 DN15	d25 DN20	d32 DN25	d40 DN32	d50 DN40	d63 DN50
5.2	Ball set T-port	1	175 482 687	175 482 687	175 482 688	175 482 689	175 482 690	175 482 691	1754826892
7	T-port ball PVDF	1							
6	Ball seal FPM	3							
11	Stem PVDF	1							
12.2	Stem seal FPM	2							
	Lever ASA	1							
8	Seal set		161 484 951	161 484 951	161 484 952	161 484 953	161 484 954	161 484 955	161 484 956
9	Backing seal FPM	3							
10	Body seal FPM	3							
11	Face seal FPM	3							
10	Stem seal FPM	2							
	Face seal FPM	1							
4	Union nut PVDF	1	175 480 819	175 480 819	175 480 820	175 480 821	175 480 822	175 480 823	175 480 824
3	Flange adaptor with socket fusion PVDF	1	175 480 031	175 480 032	175 480 033	175 480 034	175 480 035	175 480 036	175 480 037
3	Socket fusion spigot PVDF	1	175 480 787	175 480 788	175 480 789	175 480 790	175 480 791	175 480 792	175 480 793
3	Butt fusion spigot PVDF	1	175 480 796	175 480 797	175 480 798	175 480 799	175 480 800	175 480 801	175 480 802
3	Valve end PVDF NPT	1	175 480 727	175 480 728	175 480 729	175 480 730	175 480 731	175 480 732	175 480 733
3	Fixed flange PVDF serrated	1	-	735 740 106	735 740 107	735 740 108	735 740 109	735 740 110	735 740 111

Ball check valves

SYGEF® standard Ball check valve type 360 PVDF With fusion sockets metric



Model:

- For easy installation and removal
- Ball is sealing at a minimum water column 1m
- Vibration free even at high flow velocity
- FPM ball seal

Attention; make sure the inner diameter is not reduced by leaving residues of the fusion (danger of turbulence)

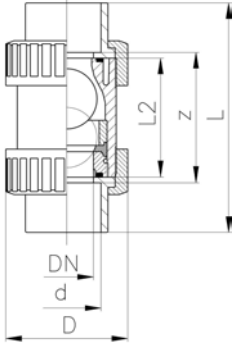

d [mm]	DN [mm]	PN	kv-value ($\Delta p=1$ bar) [l/min]	FPM Code	kg	D [mm]	L [mm]	L2 [mm]	z [mm]
16	10	16	170	175 360 411	0.152	46	98	62	72
20	15	16	150	175 360 412	0.153	46	101	62	73
25	20	16	330	175 360 413	0.253	56	119	74	87
32	25	16	390	175 360 414	0.395	67	130	78	94
40	32	16	710	175 360 415	0.625	82	149	88	109
50	40	16	900	175 360 416	1.045	98	162	94	116
63	50	16	1390	175 360 417	1.990	120	195	113	141

SYGEF® standard Ball check valve type 360 PVDF With socket fusion spigots metric



Model:

- For easy installation and removal
- Ball is sealing at a minimum water column 1m
- Vibration free even at high flow velocity
- FPM ball seal

Attention; make sure the inner diameter is not reduced by leaving residues of the fusion (danger of turbulence)

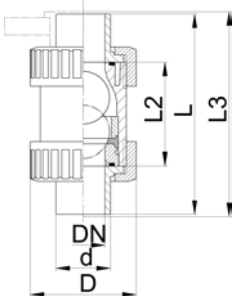

d [mm]	DN [mm]	PN	kv-value ($\Delta p=1$ bar) [l/min]	FPM Code	kg	D [mm]	L [mm]	L2 [mm]	L3 [mm]
16	10	16	170	175 360 451	0.155	46	109	62	120
20	15	16	150	175 360 452	0.156	46	119	62	130
25	20	16	330	175 360 453	0.259	56	140	74	150
32	25	16	390	175 360 454	0.406	67	150	78	160
40	32	16	710	175 360 455	0.676	82	171	88	180
50	40	16	900	175 360 456	1.086	98	191	94	200
63	50	16	1390	175 360 457	2.029	120	220	113	230



SYGEF® standard Ball check valve type 360 PVDF With butt fusion spigots metric

Model:

- For easy installation and removal
- Ball is sealing at a minimum water column 1m
- Vibration free even at high flow velocity
- FPM ball seal

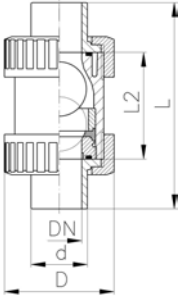

Attention; make sure the inner diameter is not reduced by leaving residues of the fusion (danger of turbulence)

d [mm]	DN [mm]	PN	kv-value ($\Delta p=1$ bar) [l/min]	FPM Code	kg	D [mm]	L [mm]	L2 [mm]
20	15	16	150	175 360 492	0.156	46	130	62
25	20	16	330	175 360 493	0.259	56	144	74
32	25	16	390	175 360 494	0.406	67	150	78
40	32	16	710	175 360 495	0.676	82	171	88
50	40	16	900	175 360 496	1.086	98	191	94
63	50	16	1390	175 360 497	2.029	120	220	113

Ball check valve silicon free/paint compatible

SYGEF® standard silicone free Ball check valve type 360 PVDF SF With fusion sockets metric



Model:

- For easy installation and removal
- Ball is sealing at a minimum water column of 2 m. Vibration free even at high velocity
- FPM ball seal

Attention; make sure the inner diameter is not reduced by leaving residues of the fusion (danger of turbulence)

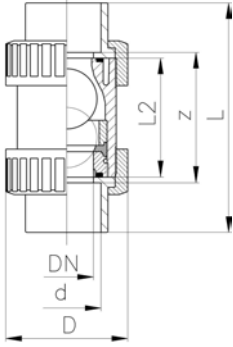

d [mm]	DN [mm]	PN	kv-value ($\Delta p=1$ bar) [l/min]	FPM Code	kg	D [mm]	L [mm]	L2 [mm]	z [mm]
16	10	16	170	175 360 611	0.152	46	98	62	72
20	15	16	150	175 360 612	0.153	46	101	62	73
25	20	16	330	175 360 613	0.253	56	119	74	87
32	25	16	390	175 360 614	0.395	67	130	78	94
40	32	16	710	175 360 615	0.663	82	149	88	109
50	40	16	900	175 360 616	1.045	98	162	94	116
63	50	16	1390	175 360 617	1.960	120	195	113	141

SYGEF® standard silicone free Ball check valve type 360 PVDF SF With butt fusion spigots metric



Model:

- For easy installation and removal
- Ball is sealing at a minimum water column of 2 m. Vibration free even at high velocity
- FPM ball seal

Attention; make sure the inner diameter is not reduced by leaving residues of the fusion (danger of turbulence)

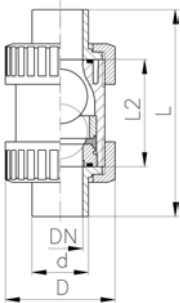

d [mm]	DN [mm]	PN	kv-value ($\Delta p=1$ bar) [l/min]	FPM Code	kg	D [mm]	L [mm]	L2 [mm]
16	10	16	170	175 360 671	0.155	46	109	62
20	15	16	150	175 360 672	0.156	46	130	62
25	20	16	330	175 360 673	0.259	56	144	74
32	25	16	390	175 360 674	0.406	67	150	78
40	32	16	710	175 360 675	0.676	82	171	88
50	40	16	900	175 360 676	1.086	98	191	94
63	50	16	1390	175 360 677	2.029	120	220	113



SYGEF® standard silicone free Ball check valve type 360 PVDF SF With socket fusion spigots metric

Model:

- For easy installation and removal
- Ball is sealing at a minimum water column of 2 m. Vibration free even at high velocity
- FPM ball seal

Attention; make sure the inner diameter is not reduced by leaving residues of the fusion (danger of turbulence)

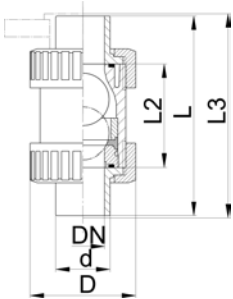

d [mm]	DN [mm]	PN	kv-value ($\Delta p=1$ bar) [l/min]	FPM Code	kg	D [mm]	L [mm]	L1 [mm]	L3 [mm]
16	10	16	170	175 360 631	0.155	46	109	62	120
20	15	16	150	175 360 632	0.156	46	119	62	130
25	20	16	330	175 360 633	0.259	56	140	74	150
32	25	16	390	175 360 634	0.406	67	150	78	160
40	32	16	710	175 360 635	0.676	82	171	88	180
50	40	16	900	175 360 636	1.086	98	191	94	200
63	50	16	1390	175 360 637	2.029	120	220	113	230

Spare parts for ball check valve type 360 PVDF

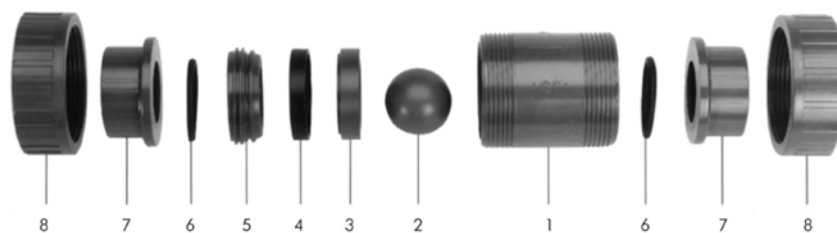

No.	Article / Material	Pieces	d16 DN10	d20 DN15	d25 DN20	d32 DN25	d40 DN32	d50 DN40	d63 DN50
7	Flange adaptor with socket fusion PVDF	1	175 480 031	175 480 032	175 480 033	175 480 034	175 480 035	175 480 036	175 480 037
7	Socket fusion spigot PVDF	1	175 480 787	175 480 788	175 480 789	175 480 790	175 480 791	175 480 792	175 480 793
7	Butt fusion spigot PVDF	1	175 480 796	175 480 797	175 480 798	175 480 799	175 480 800	175 480 801	175 480 802
7	Threaded socket PVDF NPT	1	175 480 727	175 480 728	175 480 729	175 480 730	175 480 731	175 480 732	175 480 733
7	Fixed flange PVDF serrated	1	-	735 740 106	735 740 107	735 740 108	735 740 109	735 740 110	735 740 111
2	Ball PVDF	1	175 480 153	175 480 153	175 480 154	175 480 155	175 480 156	175 480 157	175 480 158
	Seal set		161 482 920	161 482 920	161 482 921	161 482 922	161 482 923	161 482 924	161 482 925
4	Sealing ring FPM	1							
6	Union end seal FPM	2							
8	Union nut PVDF	1	175 480 819	175 480 819	175 480 820	175 480 821	175 480 822	175 480 823	175 480 824

Butterfly valves

SYGEF® standard Butterfly valve type 567 PVDF Hand lever with ratchet settings

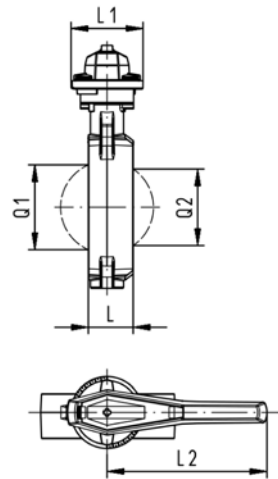
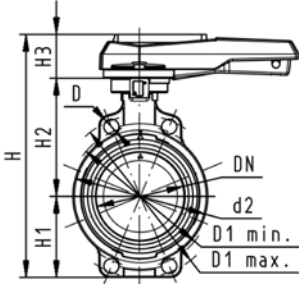

Model:

- Connecting dimension: ISO 7005 PN 10, EN 1092 PN 10, DIN 2501 PN 10, ANSI/ASME B 16.5 Class 150, BS 1560: 1989, BS 4504, JIS B 2220
- Overall length according to EN 558-1, ISO 5752

d [mm]	DN [mm]	Inch	PN	kv-value ($\Delta p=1$ bar) [l/min]	FPM Code	kg
63	50	2	10	1470	175 567 002	1.080
75	65	2 ½	10	2200	175 567 003	1.192
90	80	3	10	3000	175 567 004	1.372
110	100	4	10	6500	175 567 005	2.072
140	125	5	10	11500	175 567 006	2.667
160	150	6	10	16600	175 567 007	3.887
225	200	8	10	39600	175 567 008	6.545

d [mm]	D [mm]	D1 min. [mm]	D1 max. [mm]	d2 [mm]	H [mm]	H1 [mm]	H2 [mm]	H3 [mm]	L [mm]	L1 [mm]	L2 [mm]	Q1 [mm]	Q2 [mm]
63	19	120.0	125.0	104	264	77	134	54	45	106	205	40	
75	19	139.7	145.0	115	277	83	140	54	46	106	205	54	35
90	19	150.0	160.0	131	289	89	146	54	49	106	205	67	50
110	19	175.0	190.5	161	325	104	167	55	56	106	255	88	74
140	23	210.0	215.9	187	352	117	181	55	64	106	255	113	97
160	24	241.3	241.3	215	373	130	189	55	72	106	255	139	123
225	23	290.0	295.0	267	435	158	210	67	73	140	408	178	169



SYGEF® standard Butterfly valve type 567 PVDF Reduction gear with handwheel



Model:

- Connecting dimension: ISO 7005 PN 10, EN 1092 PN 10, DIN 2501 PN 10, ANSI/ASME B 16.5 Class 150, BS 1560: 1989, BS 4504, JIS B 2220
- Overall length according to EN 558-1, ISO 5752

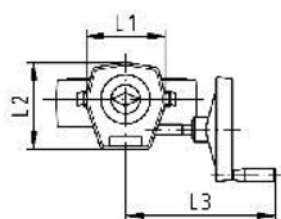
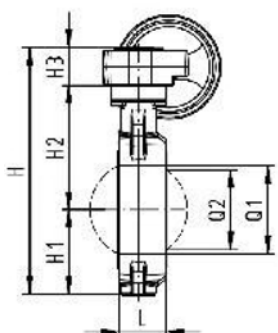
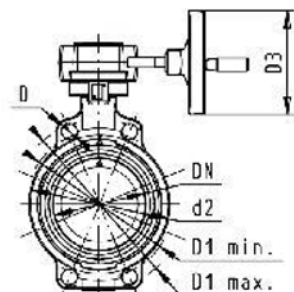

d [mm]	DN [mm]	Inch	PN	kv-value ($\Delta p=1$ bar) [l/min]	FPM Code	kg
63	50	2	10	1470	175 567 022	3.118
75	65	2 ½	10	2200	175 567 023	3.230
90	80	3	10	3000	175 567 024	3.410
110	100	4	10	6500	175 567 025	4.062
140	125	5	10	11500	175 567 026	4.657
160	150	6	10	16600	175 567 027	5.877
225	200	8	10	39600	175 567 028	7.998

d [mm]	D [mm]	D1 min. [mm]	D1 max. [mm]	d2 [mm]	D3 [mm]	H [mm]	H1 [mm]	H2 [mm]	H3 [mm]	L [mm]	L1 [mm]	L2 [mm]	L3 [mm]	Q1 [mm]
63	19	120.0	125.0	104	160	278	77	134	68	45	120	132	236	40
75	19	139.7	145.0	115	160	291	83	140	68	46	120	132	236	54
90	19	150.0	160.0	131	160	303	89	146	68	49	120	132	236	67
110	19	175.0	190.5	160	160	339	104	167	68	56	120	132	236	88
140	23	210.0	215.9	187	160	365	117	181	68	64	120	132	236	113
160	24	241.3	241.3	215	160	387	130	189	68	72	120	132	236	139
225	23	290.0	295.0	267	160	436	158	210	68	73	120	132	236	178

d [mm]	Q2 [mm]
63	
75	35
90	50
110	74
140	97
160	123
225	169



SYGEF® standard Butterfly valve type 567 PVDF Bare shaft



Model:

- Connecting dimension: ISO 7005 PN 10, EN 1092 PN 10, DIN 2501 PN 10, ANSI/ASME B 16.5 Class 150, BS 1560: 1989, BS 4504, JIS B 2220
- Overall length according to EN 558-1, ISO 5752
- Interface F07 according to DIN/ISO 5211

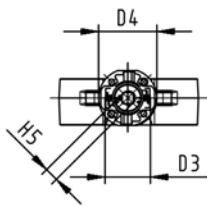
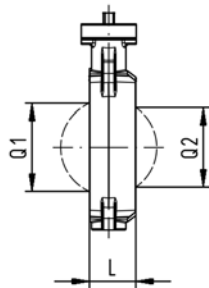
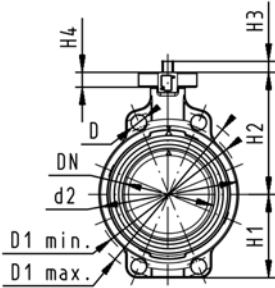

d [mm]	DN [mm]	Inch	PN	kv-value ($\Delta p=1$ bar) [l/min]	FPM Code	kg
63	50	2	10	1470	175 567 822	0.858
75	65	2 ½	10	2200	175 567 823	0.970
90	80	3	10	3000	175 567 824	1.150
110	100	4	10	6500	175 567 825	1.802
140	125	5	10	11500	175 567 826	2.397
160	150	6	10	16600	175 567 827	3.617
225	200	8	10	39600	175 567 828	5.738

d [mm]	D [mm]	D1 min. [mm]	D1 max. [mm]	d2 [mm]	D3 [mm]	D4 [mm]	H [mm]	H1 [mm]	H2 [mm]	H3 [mm]	H4 [mm]	H5 [mm]	L [mm]	Q1 [mm]
63	19	120.0	125.0	104	70	90	222	77	134	27	23	11	45	40
75	19	139.7	145.0	115	70	90	235	83	140	27	23	11	46	54
90	19	150.0	160.0	131	70	90	247	89	146	27	23	11	49	67
110	19	175.0	190.5	161	70	90	287	104	167	16	23	14	56	88
140	23	210.0	215.9	187	70	90	313	117	181	16	23	14	64	113
160	24	241.3	241.3	215	70	90	335	130	189	19	23	17	72	139
225	23	290.0	295.0	267	70	90	387	158	210	19	23	17	73	178

d [mm]	Q2 [mm]
63	
75	35
90	50
110	74
140	97
160	123
225	169



SYGEF® standard Lugstyle butterfly valve type 568 PVDF Hand lever with ratchet settings



Model:

- Outer body in GGG-40.3 epoxy-coated
- Connecting dimension: ISO 7005 PN10, EN 1092 PN10, DIN 2501 PN10
- Overall length according to EN 558-1, ISO 5752

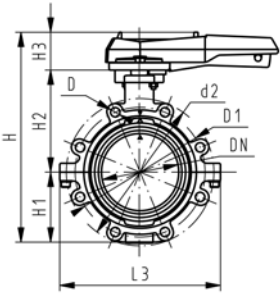

d [mm]	DN [mm]	Inch	PN	kv-value ($\Delta p=1$ bar) [l/min]	FPM Code	kg
63	50	2	10	1470	175 568 002	3.170
75	65	2 ½	10	2200	175 568 003	3.533
90	80	3	10	3000	175 568 004	4.590
110	100	4	10	6500	175 568 005	6.170
140	125	5	10	11500	175 568 006	8.151
160	150	6	10	16600	175 568 007	10.370
225	200	8	10	39600	175 568 008	16.521

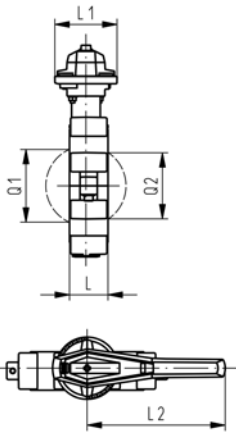

d [mm]	d2 [mm]	D	D1 [mm]	H [mm]	H1 [mm]	H2 [mm]	H3 [mm]	L [mm]	L1 [mm]	L2 [mm]	L3 [mm]	Q1 [mm]	Q2 [mm]
63	150	M16	125	265	77	134	54	45	106	205	150	40	
75	170	M16	145	277	83	140	54	46	106	205	160	54	35
90	184	M16	160	289	89	146	54	49	106	205	205	67	50
110	216	M16	180	326	104	167	55	56	106	255	244	88	74
140	246	M16	210	353	117	181	55	64	106	255	272	113	97
160	273	M20	240	374	130	189	55	72	106	255	297	139	123
225	334	M20	295	435	158	210	67	73	140	408	360	178	169

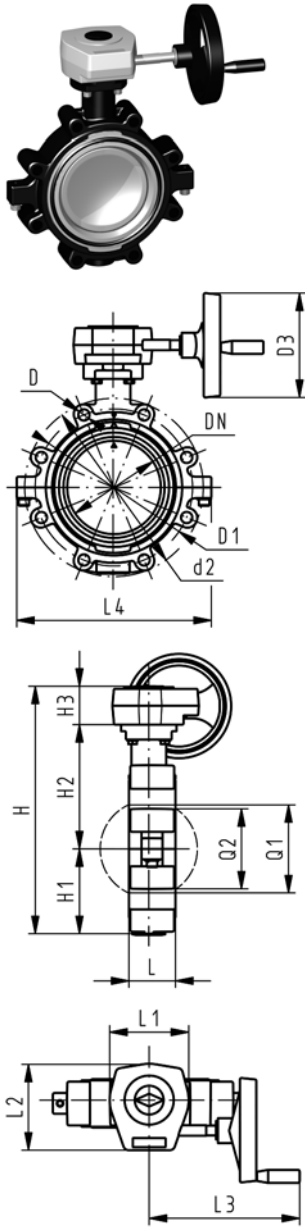

SYGEF® standard Lugstyle butterfly valve type 568 PVDF Reduction gear with handwheel



Model:

- Outer body in GGG-40.3 epoxy-coated
- Connecting dimension: ISO 7005 PN10, EN 1092 PN10, DIN 2501 PN10
- Overall length according to EN 558-1, ISO 5752

d [mm]	DN [mm]	Inch	PN	kv-value ($\Delta p=1$ bar) [l/min]	FPM Code	kg									
63	50	2	10	1470	175 568 022	5.208									
75	65	2 ½	10	2200	175 568 023	5.571									
90	80	3	10	3000	175 568 024	6.628									
110	100	4	10	6500	175 568 025	8.160									
140	125	5	10	11500	175 568 026	10.141									
160	150	6	10	16600	175 568 027	12.360									
225	200	8	10	39600	175 568 028	17.974									

d [mm]	d2 [mm]	D	D1 [mm]	D3 [mm]	H [mm]	H1 [mm]	H2 [mm]	H3 [mm]	L [mm]	L1 [mm]	L2 [mm]	L3 [mm]	L4 [mm]	Q1 [mm]	Q2 [mm]
63	150	M16	125	160	279	77	134	68	45	120	132	236	150	40	
75	170	M16	145	160	291	83	140	68	46	120	132	236	160	54	35
90	184	M16	160	160	303	89	146	68	49	120	132	236	205	67	50
110	216	M16	180	160	339	104	167	68	56	120	132	236	244	88	74
140	246	M16	210	160	366	117	181	68	64	120	132	236	272	113	97
160	273	M20	240	160	387	130	189	68	72	120	132	236	297	139	123
225	334	M20	295	160	436	158	210	68	73	120	132	236	360	178	169



SYGEF® standard Lugstyle butterfly valve type 568 PVDF Bare shaft



Model:

- Outer body in GGG-40.3 epoxy-coated
- Connecting dimension: ISO 7005 PN10, EN 1092 PN10, DIN 2501 PN10
- Overall length according to EN 558-1, ISO 5752
- Interface F07 according to DIN/ISO 5211

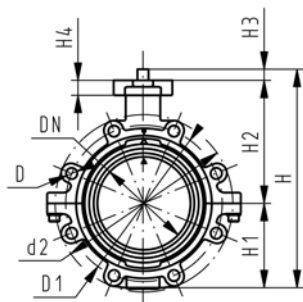

d [mm]	DN [mm]	Inch	PN	kv-value ($\Delta p=1$ bar) [l/min]	FPM Code	kg
63	50	2	10	1470	175 568 822	2.948
75	65	2 1/2	10	2200	175 568 823	3.311
90	80	3	10	3000	175 568 824	4.368
110	100	4	10	6500	175 568 825	5.900
140	125	5	10	11500	175 568 826	7.881
160	150	6	10	16600	175 568 827	10.100
225	200	8	10	39600	175 568 828	15.714

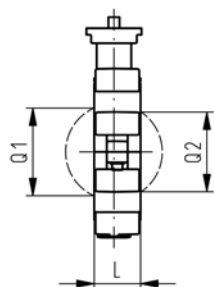

d [mm]	d2 [mm]	D	D1 [mm]	D3 [mm]	D4 [mm]	H [mm]	H1 [mm]	H2 [mm]	H3 [mm]	H4 [mm]	L [mm]	Q1 [mm]	Q2 [mm]
63	150	M16	125	70	90	222	77	134	27	23	45	40	
75	170	M16	145	70	90	235	83	140	27	23	46	54	35
90	184	M16	160	70	90	247	89	146	27	23	49	67	50
110	216	M16	180	70	90	287	104	167	16	23	56	88	74
140	246	M16	210	70	90	313	117	181	16	23	64	113	97
160	273	M20	240	70	90	335	130	189	19	23	72	139	123
225	334	M20	295	70	90	387	158	210	19	23	73	178	169

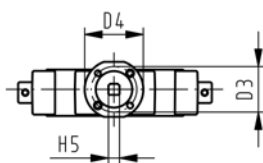



SYGEF® standard Lugstyle butterfly valve 568 PVDF ANSI Hand lever with ratchet settings



Model:

- Outer body in GGG-40.3 epoxy-coated
- Connecting dimension ANSI/ASME B 16.5 Class 150
- Overall length according to EN 558-1, ISO 5752

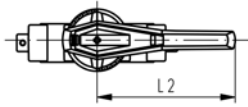
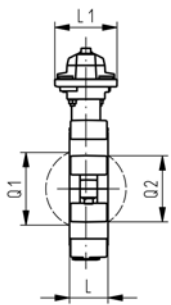
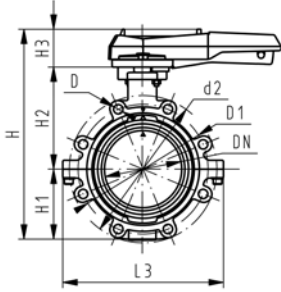

Inch	d [mm]	DN [mm]	PN	kv-value ($\Delta p=1$ bar) [l/min]	FPM Code	kg
2	63	50	10	1470	175 568 102	3.170
2 ½	75	65	10	2200	175 568 103	3.533
3	90	80	10	3000	175 568 104	3.961
4	110	100	10	6500	175 568 105	6.170
5	140	125	10	11500	175 568 106	8.151
6	160	150	10	16600	175 568 107	10.370
8	225	200	10	39600	175 568 108	16.521

Inch	d2 [mm]	D	D1 [mm]	H [mm]	H1 [mm]	H2 [mm]	H3 [mm]	L [mm]	L1 [mm]	L2 [mm]	L3 [mm]	Q1 [mm]	Q2 [mm]
2	150	UNC 5/8	121	265	77	134	54	45	106	205	150	40	
2 ½	170	UNC 5/8	138	277	83	140	54	46	106	205	160	54	35
3	177	UNC 5/8	152	289	89	146	54	49	106	205	175	67	50
4	216	UNC 5/8	191	326	104	167	55	56	106	255	244	88	74
5	246	UNC 3/4	216	353	117	181	55	64	106	255	272	113	97
6	273	UNC 3/4	241	374	130	189	55	72	106	255	297	139	123
8	334	UNC 3/4	298	435	158	210	67	73	140	408	360	178	169



SYGEF® standard Lugstyle butterfly valve 568 PVDF ANSI Reduction gear with handwheel



Model:

- Outer body in GGG-40.3 epoxy-coated
- Connecting dimension ANSI/ASME B 16.5 Class 150
- Overall length according to EN 558-1, ISO 5752

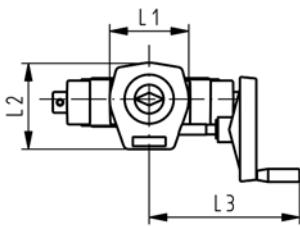
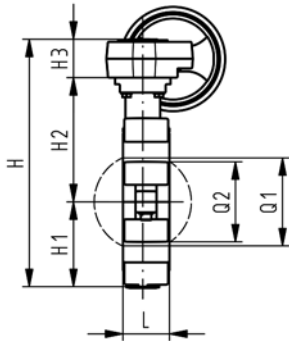
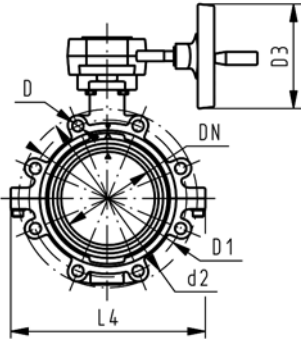

Inch	d [mm]	DN [mm]	PN	kv-value ($\Delta p=1$ bar) [l/min]	FPM Code	kg
2	63	50	10	1470	175 568 122	5.208
2 ½	75	65	10	2200	175 568 123	5.571
3	90	80	10	3000	175 568 124	5.999
4	110	100	10	6500	175 568 125	8.160
5	140	125	10	11500	175 568 126	10.141
6	160	150	10	16600	175 568 127	12.360
8	225	200	10	39600	175 568 128	17.974

Inch	d2 [mm]	D	D1 [mm]	D3 [mm]	H [mm]	H1 [mm]	H2 [mm]	H3 [mm]	L [mm]	L1 [mm]	L2 [mm]	L3 [mm]	L4 [mm]	Q1 [mm]
2	150	UNC 5/8	121	160	279	77	134	68	45	120	132	236	150	40
2 ½	170	UNC 5/8	138	160	291	83	140	68	46	120	132	236	160	54
3	177	UNC 5/8	152	160	303	89	146	68	49	120	132	236	175	67
4	216	UNC 5/8	191	160	339	104	167	68	56	120	132	236	244	88
5	246	UNC 3/4	216	160	366	117	181	68	64	120	132	236	272	113
6	273	UNC 3/4	241	160	387	130	189	68	72	120	132	236	297	139
8	334	UNC 3/4	298	160	436	158	210	68	73	120	132	236	360	178

Inch	Q2 [mm]
2	
2 ½	35
3	50
4	74
5	97
6	123
8	169



SYGEF® standard Lugstyle butterfly valve 568 PVDF ANSI Bare shaft



Model:

- Outer body in GGG-40.3 epoxy-coated
- Connecting dimension ANSI/ASME B 16.5 Class 150
- Overall length according to EN 558-1, ISO 5752
- Interface F07 according to DIN/ISO 5211

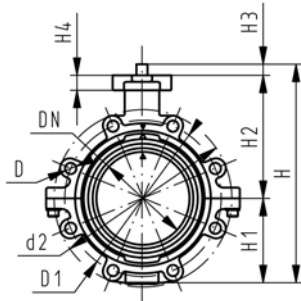

Inch	d [mm]	DN [mm]	PN	kv-value ($\Delta p=1$ bar) [l/min]	FPM Code	kg
2	63	50	10	1470	175 568 922	2.948
2 ½	75	65	10	2200	175 568 923	3.311
3	90	80	10	3000	175 568 924	3.739
4	110	100	10	6500	175 568 925	5.900
5	140	125	10	11500	175 568 926	7.881
6	160	150	10	16600	175 568 927	10.100
8	225	200	10	39600	175 568 928	15.714

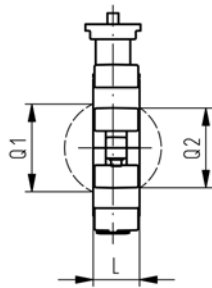

Inch	d2 [mm]	D	D1 [mm]	D3 [mm]	D4 [mm]	H [mm]	H1 [mm]	H2 [mm]	H3 [mm]	H4 [mm]	L [mm]	Q1 [mm]	Q2 [mm]
2	150	UNC 5/8	121	70	90	222	77	134	27	23	45	40	
2 ½	170	UNC 5/8	138	70	90	235	83	140	27	23	46	54	35
3	177	UNC 5/8	152	70	90	247	89	146	27	23	49	67	50
4	216	UNC 5/8	191	70	90	287	104	167	16	23	56	88	74
5	246	UNC 3/4	216	70	90	313	117	181	16	23	64	113	97
6	273	UNC 3/4	241	70	90	335	130	189	19	23	72	139	123
8	334	UNC 3/4	298	70	90	387	158	210	19	23	73	178	169

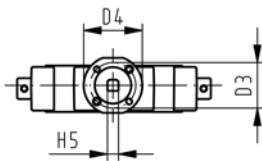

Spare parts for butterfly valve type 567 PVDF Hand lever with index plate

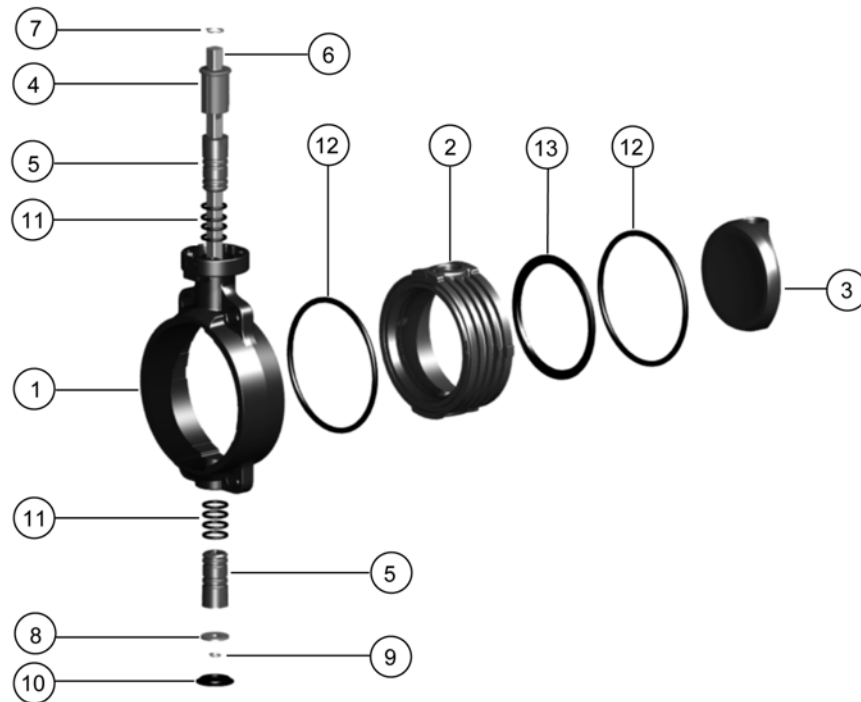

No.	Article / Material	Pieces	d63 DN50	d75 DN65	d90 DN80	d110 DN100	d140 DN125	d160 DN150	d225 DN200
3	Disc PVDF	1	175 483 251	175 483 252	175 483 253	175 483 254	175 483 255	175 483 256	175 483 257
5	Bearing bush	2	175 483 426	175 483 426	175 483 426	175 483 427	175 483 427	175 483 428	175 483 428
	Bush PVDF								
11	O-ring FPM								
2	Inner body	1	175 483 413	175 483 414	175 483 415	175 483 416	175 483 417	175 483 418	175 483 419
	Body PVDF								
13	Profile seal FPM	1							
12	Flange gasket EPDM	2	161 486 959	161 486 960	161 486 961	161 486 962	161 486 963	161 486 964	161 486 965
12	Flange gasket FPM	2	161 486 979	161 486 980	161 486 981	161 486 982	161 486 983	161 486 984	161 486 985
4	End stop PP Glasfiber Reinforced	1	167 486 251	167 486 251	167 486 251	167 483 252	167 483 252	167 483 253	167 483 253
6	Shaft set	1	161 486 899	161 486 900	161 486 901	161 486 902	161 486 903	161 486 904	161 486 905
	Shaft Chrom Steel 1.4301 AISI 304								
7+9	Retention ring	2							
8	Washer	1							
	Hand lever with index plate Lever	1	161 486 690	161 486 690	161 486 690	161 486 691	161 486 691	161 486 694	161 486 695

Wafer check valves

SYGEF® standard Wafer check valve type 369 PVDF Without springs

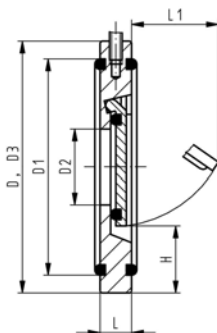

Model:

- Supporting eyelets for simple fitting
- Suitable for vertical and horizontal mounting

Installation instruction:

- Installation between metric flange adaptors
- Centering by body diameter
- Sealing with special flange gasket (except DN32, o-ring)
- A stabilizing zone of at least 5 times nominal diameter (DN) should be provided before and after the wafer check valve (10 times DN is recommended)
- No direct installation on pump flange or following bend allowed

Note:

- In order to install the wafer check valves properly, Georg Fischer recommends flange adaptors of the next larger diameter of the valve (e.g. wafer check valve d90 with two flange adaptors d110)

d [mm]	DN [mm]	PN	FPM Code	kg
40	32	6	175 369 022	0.170
50	40	6	175 369 023	0.210
63	50	6	175 369 024	0.330
75	65	6	175 369 025	0.420
90	80	6	175 369 026	0.510
110	100	6	175 369 027	0.710
140	125	6	175 369 029	0.970
160	150	6	175 369 030	1.420
225	200	6	175 369 031	2.710
280	250	6	175 369 032	4.520
315	300	6	175 369 033	6.900

d [mm]	D [mm]	D1 [mm]	D2 [mm]	H [mm]	L [mm]	L1 [mm]	Opening pressure vertical without spring in [mbar]	Opening pressure horizontal without spring in [mbar]	Tightness from water column [m H ₂ O]
40	85	59	18	25	15	22	10	1	2.0
50	95	72	22	28	16	25	10	1	2.0
63	109	86	32	29	18	37	10	1	2.0
75	129	105	40	31	20	50	10	1	2.0
90	144	119	54	32	20	61	10	1	2.0
110	164	146	70	31	23	77	10	1	2.0
140	195	173	92	35	23	94	10	1	2.0
160	220	197	112	35	26	115	10	1	2.0
225	275	255	154	38	35	152	18	1	2.0
280	330	312	192	41	40	180	18	1	2.0
315	380	363	227	41	45	215	18	1	2.0

d [mm]	Number of screws with washer	Torque [Nm]	Number of nut rotations after tightening by hand
40	4xM16/90	10	1
50	4xM16/95	12	1
63	4xM16/110	15	1
75	4xM16/140	18	1
90	8xM16/150	20	1
110	8xM16/160	22	1
140	8xM16/180	25	1
160	8xM20/200	30	1
225	8xM20/220	60	1
280	12xM20/240	60	1
315	12xM20/160	60	1



SYGEF® standard Wafer check valve type 369 PVDF With V4A springs

Model:

- Supporting eyelets for simple fitting
- Suitable for vertical and horizontal mounting

Installation instruction:

- Installation between metric flange adaptors
- Centering by body diameter
- Sealing with special flange gasket (except DN32, o-ring)
- A stabilizing zone of at least 5 times nominal diameter (DN) should be provided before and after the wafer check valve (10 times DN is recommended)
- No direct installation on pump flange or following bend allowed

Note:

- In order to install the wafer check valves properly, Georg Fischer recommends flange adaptors of the next larger diameter of the valve (e.g. wafer check valve d90 with two flange adaptors d110)

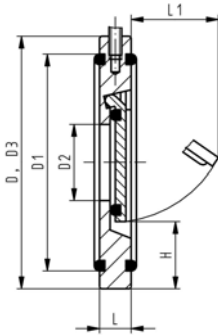

d [mm]	DN [mm]	PN	FPM Code	kg
40	32	6	175 369 062	0.170
50	40	6	175 369 063	0.210
63	50	6	175 369 064	0.330
75	65	6	175 369 065	0.420
90	80	6	175 369 066	0.510
110	100	6	175 369 067	0.710
140	125	6	175 369 069	0.970
160	150	6	175 369 070	1.420
225	200	6	175 369 071	2.710
280	250	6	175 369 072	4.520
315	300	6	175 369 073	6.900

d [mm]	D [mm]	D1 [mm]	D2 [mm]	H [mm]	L [mm]	L1 [mm]	Tightness from water column [m H2O]	Opening pressure horizontal [mbar]	Number of screws with washer
40	85	59	18	25	15	22	2.0	20	4xM16/90
50	95	72	22	28	16	25	2.0	20	4xM16/95
63	109	86	32	29	18	37	2.0	20	4xM16/110
75	129	105	40	31	20	50	2.0	20	4xM16/140
90	144	119	54	32	20	61	2.0	20	8xM16/150
110	164	146	70	31	23	77	2.0	20	8xM16/160
140	195	173	92	35	23	94	2.0	20	8xM16/180
160	220	197	112	35	26	115	2.0	20	8xM20/200
225	275	255	154	38	35	152	2.0	20	8xM20/220
280	330	312	192	41	40	180	2.0	20	12xM20/240
315	380	363	227	41	45	215	2.0	20	12xM20/260

d [mm]	Torque [Nm]	Number of nut rotations after tightening by hand
40	10	1
50	12	1
63	15	1
75	18	1
90	20	1
110	22	1
140	25	1
160	30	1
225	60	1
280	60	1
315	60	1

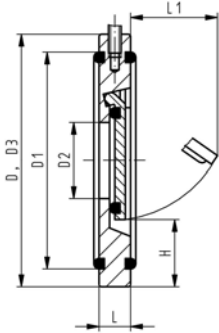

SYGEF® standard Wafer check valve type 369 PVDF With hastelloy C springs

Model:

- Supporting eyelets for simple fitting
- Suitable for vertical and horizontal mounting

Installation instruction:

- Installation between metric flange adaptors
- Centering by body diameter
- Sealing with special flange gasket (except DN32, o-ring)
- A stabilizing zone of at least 5 times nominal diameter (DN) should be provided before and after the wafer check valve (10 times DN is recommended)
- No direct installation on pump flange or following bend allowed

Note:

- In order to install the wafer check valves properly, Georg Fischer recommends flange adaptors of the next larger diameter of the valve (e.g. wafer check valve d90 with two flange adaptors d110)

d [mm]	DN [mm]	Inch	PN	FPM Code	kg
40	32		6	175 369 102	0.170
50	40		6	175 369 103	0.210
63	50		6	175 369 104	0.330
75	65		6	175 369 105	0.420
90	80		6	175 369 106	0.510
110	100		6	175 369 107	0.710
140	125		6	175 369 109	0.970
160	150		6	175 369 110	1.420
225	200		6	175 369 111	2.710
280	250		6	175 369 112	4.520
315	300		6	175 369 113	6.900

d [mm]	D [mm]	D1 [mm]	D2 [mm]	H [mm]	L [mm]	L1 [mm]	Opening pressure vertical [mbar]	Tightness from water column [m H ₂ O]	Opening pressure horizontal [mbar]
40	85	59	18	25	15	22		2.0	20
50	95	72	22	28	16	25		2.0	20
63	109	86	32	29	18	37		2.0	20
75	129	105	40	31	20	50		2.0	20
90	144	119	54	32	20	61		2.0	20
110	164	146	70	31	23	77		2.0	20
140	195	173	92	35	23	94		2.0	20
160	220	197	112	35	26	115		2.0	20
225	275	255	154	38	35	152		2.0	20
280	330	312	192	41	40	180		2.0	20
315	380	363	227	41	45	215		2.0	20

d [mm]	Number of screws with washer	Torque [Nm]	Number of nut rotations after tightening by hand
40	4xM16/90	10	1
50	4xM16/95	12	1
63	4xM16/110	15	1
75	4xM16/140	18	1
90	8xM16/150	20	1
110	8xM16/160	22	1
140	8xM16/180	25	1
160	8xM20/200	30	1
225	8xM20/220	60	1
280	12xM20/240	60	1
315	12xM20/260	60	1

Spare parts for wafer check valve type 369 PVDF

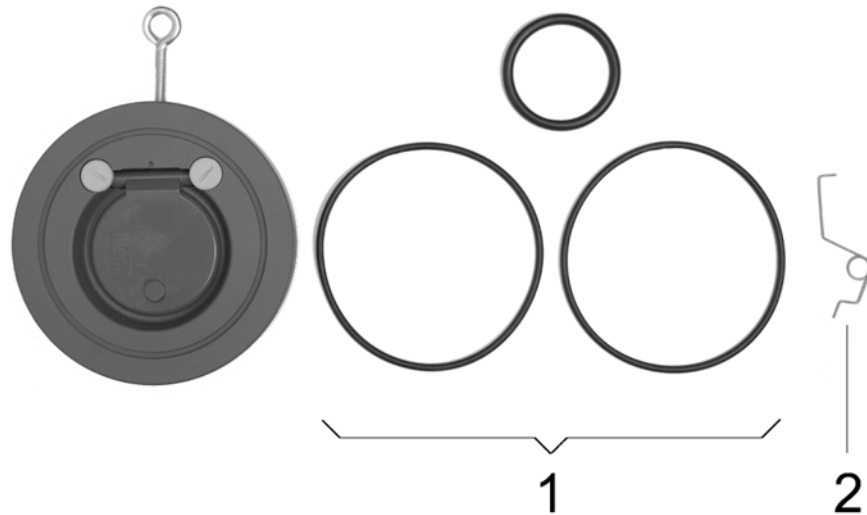

No.	Article / Material	Pieces	d40 DN32	d50 DN40	d63 DN50	d75 DN65	d90 DN80	d110 DN100	d140 DN125
	Seal set		161 484 875	161 484 876	161 484 877	161 484 878	161 484 879	161 484 880	161 484 881
1	Body seal EPDM	2							
1	Seal EPDM	1							
	Seal set		161 484 887	161 484 888	161 484 889	161 484 890	161 484 891	161 484 892	161 484 893
1	Body seal FPM	2							
1	Seal FPM	1							
2	Spring Hastelloy C	1	161 484 912	161 484 913	161 484 914	161 484 915	161 484 916	161 484 917	161 484 918

No.	Article / Material	Pieces	d160 DN150	d225 DN200	d280 DN250	d315 DN300
	Seal set		161 484 892	1614848893	1614848894	1614848895
1	Body seal EPDM	2				
1	Seal EPDM	1				
	Seal set		161 484 894	161 484 895	161 484 896	161 484 897
1	Body seal FPM	2				
1	Seal FPM	1				
2	Spring Hastelloy C	1	161 484 919	161 484 920	161 484 921	1614849122

SYGEF® Plus

		Page
	Pipes	106
	Butt Fusion Fittings	107
	Transition Fittings	118
	Sanitary Adaptors	120
	Diaphragm valves	123

Pipes

Pipe, PN 16, PVDF-HP

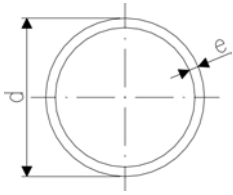

d [mm]	PN	Code	e [mm]	Weight [kg/m]	Length [m]
16	16	175 481 202	1.9	0.132	5.00
20	16	175 481 203	1.9	0.209	5.00
25	16	175 481 204	1.9	0.278	5.00
32	16	175 481 205	2.4	0.425	5.00
40	16	175 481 206	2.4	0.550	5.00
50	16	175 481 207	3.0	0.835	5.00
63	16	175 481 208	3.0	1.080	5.00
75	16	175 481 209	3.6	1.519	5.00
90	16	175 481 210	4.3	2.210	5.00
110	16	175 481 211	5.3	3.336	5.00
125	16	175 481 212	6.0	4.424	5.00
160	16	175 481 214	7.7	6.960	5.00
140	16	175 481 213	6.7	5.310	5.00
200	16	175 481 216	9.6	10.800	5.00
225	16	175 481 217	10.8	13.700	5.00

Pipe, PN 10, PVDF-HP

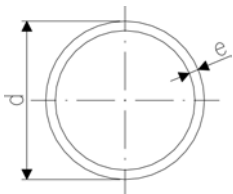

d [mm]	PN	Code	e [mm]	Weight [kg/m]	Length [m]
90	10	175 481 665	2.8	1.565	5.00
110	10	175 481 666	3.4	2.140	5.00
125	10	175 481 667	3.9	2.800	5.00
140	10	175 481 673	4.3	3.710	5.00
160	10	175 481 668	4.9	4.657	5.00
200	10	175 481 669	6.2	6.916	5.00
225	10	175 481 670	6.9	9.162	5.00
250	10	175 481 671	7.7	11.100	5.00
280	10	175 481 656	8.6	13.900	5.00
315	10	175 481 674	9.7	17.600	5.00

Butt Fusion Fittings

Bend 90°, PN 16, PVDF-HP

- * new model with compact design and optimized flow values

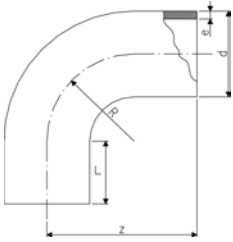

d [mm]	PN	Code	kg	e [mm]	L [mm]	z [mm]	R [mm]	
20	16	735 018 731	0.015	1.9	23	38	15	
25	16	735 018 732	0.021	1.9	23	42	19	
32	16	735 018 733	0.035	2.4	22	46	24	
40	16	735 018 734	0.050	2.4	21	51	30	
50	16	735 018 735	0.087	3.0	21	58	37	
63	16	735 018 736	0.128	3.0	21	66	45	
75	16	735 018 737	0.243	3.6	23	75	62	
90	16	735 018 738	0.385	4.3	23	90	77	
110	16	735 018 739	0.643	5.3	23	110	98	
140	16	735 018 741	1.423	6.7	33	140	121	
160	16	735 018 742	2.052	7.7	33	160	141	
200	16	735 018 744	3.798	9.6	33	200	181	
225	16	735 018 745	5.274	10.8	33	220	200	

Bend 90°, PN 10, PVDF-HP

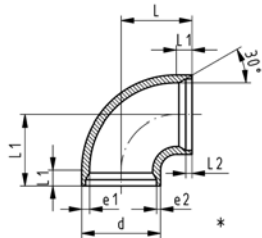
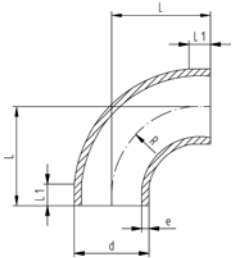
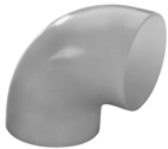

d [mm]	PN	Code	kg	e [mm]	L [mm]	L1 [mm]	e1 [mm]	L2 [mm]	
90	10	735 018 538	0.294	2.8	90	23			
110	10	735 018 539	0.578	3.4	110	23			
125	10	735 018 540	0.670	3.9	125	28			
140	10	735 018 541	0.970	4.3	140	33			
160	10	735 018 542	1.440	4.7	160	33			
200	10	735 018 544	2.730	6.2	200	33			
225	10	735 018 545	3.900	6.9	220	33			
250	10	735 018 546	8.040	7.7	254	48			
*280	10	735 018 547	11.200	8.6	283	48	17.2	10	
*315	10	735 018 548	15.900	9.7	321	48	19.3	10	

Elbow 90°, PN 16, PVDF-HP

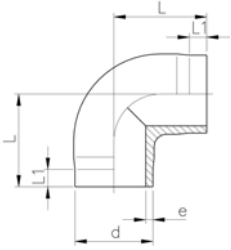

d [mm]	PN	Code	kg	e [mm]	L [mm]	L1 [mm]
20	16	735 108 631	0.017	1.9	38	25
25	16	735 108 632	0.023	1.9	42	26
32	16	735 108 633	0.040	2.4	46	26
40	16	735 108 634	0.060	2.4	51	28
50	16	735 108 635	0.105	3.0	58	28
63	16	735 108 636	0.180	3.0	66	28

Elbow 45°, PN 16, PVDF-HP

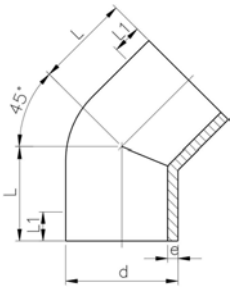

d [mm]	PN	Code	kg	e [mm]	L [mm]	L1 [mm]
20	16	735 158 631	0.014	1.9	32	25
25	16	735 158 632	0.019	1.9	34	26
32	16	735 158 633	0.033	2.4	36	26
40	16	735 158 634	0.048	2.4	39	28
50	16	735 158 635	0.079	3.0	42	30
63	16	735 158 636	0.116	3.0	47	31
75	16	735 158 637	0.160	3.6	49	32
90	16	735 158 638	0.260	4.3	57	37
110	16	735 158 639	0.480	5.3	70	46
140	16	735 158 641	1.000	6.7	88	57
160	16	735 158 642	2.300	7.7	100	62
200	16	735 158 644	2.800	9.6	124	77
225	16	735 158 645	4.000	10.8	140	88

Elbow 45°, PN 10, PVDF-HP

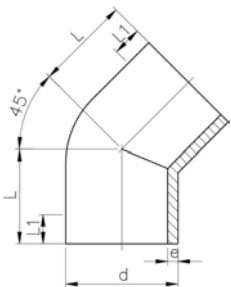

d [mm]	PN	Code	kg	e [mm]	L [mm]	L1 [mm]
90	10	735 158 538	0.181	2.8	57	37
110	10	735 158 539	0.330	3.4	70	46
125	10	735 158 540	0.490	3.9	79	51
140	10	735 158 541	0.680	4.3	88	57
160	10	735 158 542	0.990	4.9	100	62
200	10	735 158 544	1.940	6.2	124	77
225	10	735 158 545	2.780	6.9	140	88

T 90° equal, PN 16, PVDF-HP

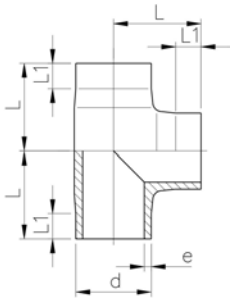

d [mm]	PN	Code	kg	e [mm]	L [mm]	L1 [mm]
20	16	735 208 631	0.023	1.9	38	25
25	16	735 208 632	0.032	1.9	42	27
32	16	735 208 633	0.056	2.4	46	27
40	16	735 208 634	0.083	2.4	51	28
50	16	735 208 635	0.140	3.0	58	28
63	16	735 208 636	0.231	3.0	66	28
75	16	735 208 637	0.370	3.6	75	32
90	16	735 208 638	0.660	4.3	90	39
110	16	735 208 639	1.210	5.3	110	48
140	16	735 208 641	2.600	6.7	140	62
160	16	735 208 642	5.200	7.7	160	71
200	16	735 208 644	6.630	9.6	200	80
225	16	735 208 645	9.120	10.8	220	86

T 90° equal, PN 10, PVDF-HP

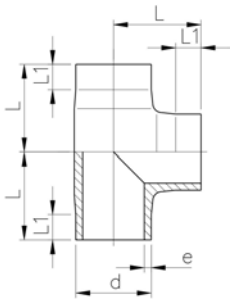

d [mm]	PN	Code	kg	e [mm]	L [mm]	L1 [mm]
90	10	735 208 538	0.397	2.8	90	39
110	10	735 208 539	0.714	3.4	110	48
125	10	735 208 540	1.280	3.9	125	56
140	10	735 208 541	1.780	4.3	140	62
160	10	735 208 542	2.570	4.9	160	71
200	10	735 208 544	4.297	6.2	200	80
225	10	735 208 545	6.800	6.9	220	86
250	10	735 208 546	9.281	7.7	223	61
280	10	735 208 547	13.608	8.6	256	74
315	10	735 208 548	18.128	9.7	274	74



T 90° reduced, PN 16, PVDF-HP

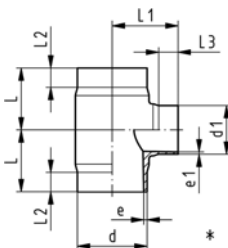
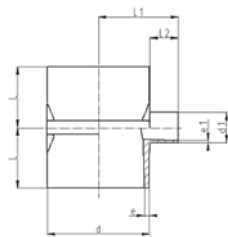

d - d1 [mm]	PN	Code	kg	e [mm]	e1 [mm]	L [mm]	L1 [mm]	L2 [mm]	L3 [mm]
63 - 20	16	735 208 956	0.213	3.0	1.9	60	67	25	35
63 - 25	16	735 208 957	0.214	3.0	1.9	60	66	25	34
63 - 32	16	735 208 958	0.220	3.0	2.4	60	67	25	25
63 - 40	16	735 208 959	0.217	3.0	2.4	60	66	25	26
75 - 20	16	735 208 961	0.306	3.6	1.9	65	69	25	31
75 - 25	16	735 208 962	0.308	3.6	1.9	65	72	25	34
75 - 32	16	735 208 963	0.308	3.6	2.4	65	69	25	31
75 - 40	16	735 208 964	0.312	3.6	2.4	65	72	25	26
75 - 50	16	735 208 965	0.309	3.6	3.0	65	69	25	26
90 - 20	16	735 208 967	0.403	4.3	1.9	65	76	25	31
90 - 25	16	735 208 968	0.405	4.3	1.9	65	79	25	34
90 - 32	16	735 208 969	0.405	4.3	2.4	65	76	25	31
90 - 40	16	735 208 970	0.409	4.3	2.4	65	79	25	26
90 - 50	16	735 208 971	0.406	4.3	3.0	65	76	25	26
*90 - 63	16	735 208 972	0.540	4.3	3.0	80	85	25	25
110 - 20	16	735 208 974	0.568	5.3	1.9	65	86	25	31
110 - 25	16	735 208 975	0.570	5.3	1.9	65	89	25	34
110 - 32	16	735 208 976	0.570	5.3	2.4	65	86	25	31
110 - 40	16	735 208 977	0.572	5.3	2.4	65	89	25	26
110 - 50	16	735 208 978	0.568	5.3	3.0	65	86	25	26
*110 - 63	16	735 208 979	0.853	5.3	3.0	90	95	30	25
*110 - 75	16	735 208 980	0.863	5.3	3.0	90	95	30	25
*110 - 90	16	735 208 981	0.870	5.3	4.3	90	95	30	25
*160 - 90	16	735 208 687	3.200	7.7	4.3	155	130	60	25
*160 - 110	16	735 208 686	3.300	7.7	5.3	155	130	60	25
*225 - 90	16	735 208 695	6.000	10.8	4.3	155	160	60	25
*225 - 110	16	735 208 694	6.100	10.8	5.3	155	160	60	25



T 90° reduced, PN 10, PVDF-HP

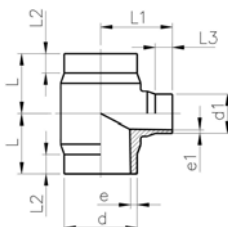

d - d1 [mm]	PN [bar]	Code	kg	e [mm]	e1 [mm]	L [mm]	L1 [mm]	L2 [mm]	L3 [mm]
160 - 90	10 / 16	735 208 587	2.300	4.9	4.3	155	130	60	25
160 - 110	10 / 16	735 208 586	2.300	4.9	5.3	155	130	60	25
225 - 90	10 / 16	735 208 595	4.400	6.9	4.3	155	160	60	25
225 - 110	10 / 16	735 208 594	4.400	6.9	5.3	155	160	60	25

Flange Adaptor, PN 16, jointing face serrated, PVDF-HP

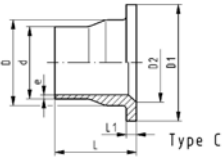
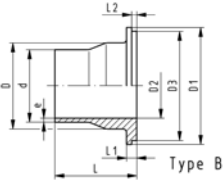
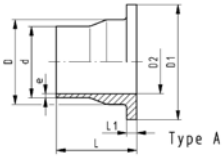

d [mm]	DN [mm]	PN	Code	kg	D [mm]	D1 [mm]	D2 [mm]	D3 [mm]	e [mm]	L [mm]	L1 [mm]	L2 [mm]	Type
20	15	16	735 798 831	0.029	26	45	15		1.9	54	6		A
25	20	16	735 798 832	0.044	32	58	20	54	1.9	56	7	4	B
32	25	16	735 798 833	0.066	40	68	26	63	2.4	58	7	4	B
40	32	16	735 798 834	0.093	49	78	34	73	2.4	68	8	4	B
50	40	16	735 798 835	0.129	60	88	42	82	3.0	69	8	4	B
63	50	16	735 798 836	0.187	75	102	56		3.0	72	9		A
75	65	16	735 798 837	0.298	89	122	66		3.6	80	10		A
90	80	16	735 798 838	0.377	105	138	78	133	4.3	81	12	4	B
110	100	16	735 798 839	0.630	125	158	100		5.3	81	13		C
140	125	16	735 798 841	0.847	155	188	127		6.7	90	16		C
160	150	16	735 798 842	1.200	175	212	151		7.7	93	17		C
200	200	16	735 798 844	1.900	232	268	203		9.6	102	22		C
225	200	16	735 798 845	2.000	235	268	203		10.8	102	22		C

Flange Adaptor, PN 10, jointing face serrated, PVDF-HP

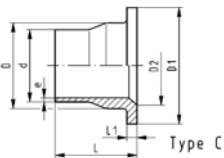
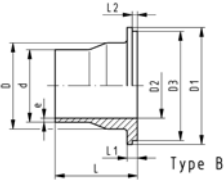
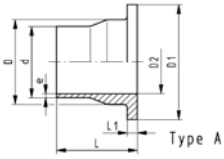

d [mm]	DN [mm]	PN	Code	kg	D [mm]	D1 [mm]	D2 [mm]	D3 [mm]	e [mm]	L [mm]	L1 [mm]	L2 [mm]	Type
90	80	10	735 798 888	0.350	105	138	78	133	2.8	81	12	4	B
110	100	10	735 798 889	0.450	125	158	100		3.4	81	13		A
125	100	10	735 798 590	0.480	132	158	114		3.9	82	14		A
140	125	10	735 798 891	0.710	155	188	127		4.3	90	16		A
160	150	10	735 798 892	1.000	175	212	151		4.9	93	17		C
200	200	10	735 798 894	1.700	232	268	203		6.2	102	22		C
225	200	10	735 798 895	1.600	235	268	203		6.9	102	22		A
250	250	10	735 798 596	2.673	285	320	250		7.7	120	22		C
280	250	10	735 798 597	2.777	291	320	250		8.6	120	22		A
315	300	10	735 798 598	3.436	335	370	300		9.7	120	22		C

Flange Adaptor, PN16, ANSI, jointing face serrated, PVDF-HP

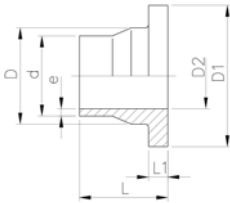

Model:

- Other dimensions identical with metric version

d [mm]	PN	Code	kg	D [mm]	D1 [mm]	D2 [mm]	e [mm]	L [mm]	L1 [mm]
25	16	735 798 882	0.043	32	54	20	1.9	56	7
32	16	735 798 883	0.063	40	63	26	2.4	58	7
40	16	735 798 884	0.089	49	73	34	2.4	68	8
50	16	735 798 885	0.123	60	82	43	3.0	69	8
90	16	735 798 886	0.362	105	133	78	4.3	81	12

Reducer, PN 16, PVDF-HP

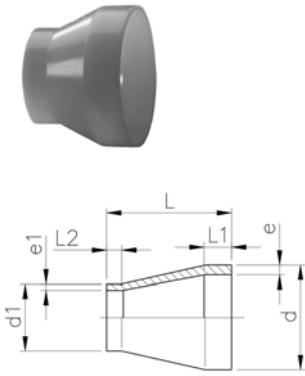

d - d1 [mm]	PN	Code	kg	e [mm]	e1 [mm]	L [mm]	L1 [mm]	L2 [mm]	
25 - 20	16	735 908 600	0.012	1.9	1.9	50	22	22	
32 - 20	16	735 908 602	0.017	2.4	1.9	50	22	22	
32 - 25	16	735 908 601	0.018	2.4	1.9	50	22	22	
40 - 20	16	735 908 605	0.024	2.4	1.9	58	22	24	
40 - 25	16	735 908 604	0.025	2.4	1.9	55	22	24	
40 - 32	16	735 908 603	0.029	2.4	2.4	55	22	24	
50 - 25	16	735 908 608	0.031	3.0	1.9	60	22	25	
50 - 32	16	735 908 607	0.038	3.0	2.4	60	22	25	
50 - 40	16	735 908 606	0.040	3.0	2.4	60	22	25	
63 - 32	16	735 908 611	0.050	3.0	2.4	65	22	25	
63 - 40	16	735 908 610	0.052	3.0	2.4	65	22	25	
63 - 50	16	735 908 609	0.060	3.0	3.0	65	22	25	
75 - 40	16	735 908 614	0.069	3.6	2.4	68	24	25	
75 - 50	16	735 908 613	0.078	3.6	3.0	65	24	25	
75 - 63	16	735 908 612	0.080	3.6	3.0	65	24	25	
90 - 63	16	735 908 616	0.120	4.3	3.0	75	25	30	
90 - 75	16	735 908 615	0.130	4.3	3.6	75	25	35	
110 - 63	16	735 908 619	0.225	5.3	3.0	90	30	30	
110 - 75	16	735 908 618	0.220	5.3	3.6	90	30	35	
110 - 90	16	735 908 617	0.230	5.3	4.3	90	30	35	
140 - 110	16	735 908 621	0.450	6.7	5.3	110	40	40	
160 - 110	16	735 908 623	1.000	7.7	5.3	120	40	40	
160 - 140	16	735 908 622	0.660	7.7	6.7	120	40	40	
200 - 160	16	735 908 624	1.340	9.6	7.7	145	40	35	
225 - 110	16	735 908 625	1.540	10.8	5.3	160	55	40	
225 - 160	16	735 908 626	1.730	10.8	7.7	160	55	28	
225 - 200	16	735 908 627	1.980	10.8	9.6	160	55	50	

Reducer, PN 10, PVDF-HP

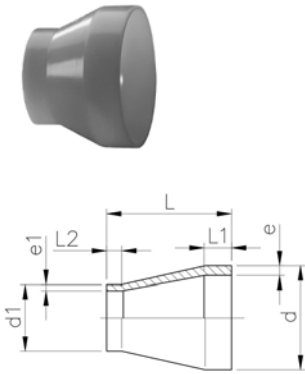

d - d1 [mm]	PN [bar]	Code	kg	e [mm]	e1 [mm]	L [mm]	L1 [mm]	L2 [mm]	
90 - 63	10 / 16	735 908 511	0.102	2.8	3.0	75	25	30	
110 - 63	10 / 16	735 908 513	0.164	3.4	3.0	90	30	30	
110 - 90	10 / 10	735 908 515	0.167	3.4	2.8	90	30	35	
125 - 110	10 / 16	735 908 500	0.270	3.9	5.3	100	35	40	
140 - 110	10 / 16	735 908 502	0.385	4.3	5.3	110	40	40	
140 - 125	10 / 10	735 908 501	0.340	4.3	3.9	110	40	40	
160 - 110	10 / 10	735 908 521	0.449	4.9	3.4	120	40	40	
160 - 110	10 / 16	735 908 504	0.425	4.9	5.3	120	40	40	
160 - 140	10 / 10	735 908 503	0.460	4.9	4.3	120	40	40	
200 - 160	10 / 10	735 908 505	0.830	6.2	4.9	145	50	40	
225 - 110	10 / 10	735 908 526	1.120	6.9	3.4	160	55	35	
225 - 110	10 / 16	735 908 506	0.940	6.9	5.3	160	55	35	
225 - 160	10 / 10	735 908 507	1.140	6.9	4.9	160	55	40	
225 - 200	10 / 10	735 908 508	1.200	6.9	6.2	160	55	50	
250 - 225	10 / 10	735 908 531	1.871	7.7	6.9	182	60	55	
280 - 225	10 / 10	735 908 532	2.518	8.6	6.9	206	70	55	
315 - 225	10 / 10	735 908 533	3.456	9.7	6.9	231	80	55	

Reducing Bush, eccentric, PN 16, PVDF-HP

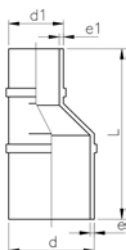

d - d1 [mm]	Code	kg	e [mm]	e1 [mm]	L [mm]
25 - 20	735 938 737	0.020	1.9	1.9	80
32 - 20	735 938 742	0.027	2.4	1.9	80
32 - 25	735 938 741	0.028	2.4	1.9	80
40 - 20	735 938 748	0.041	2.4	1.9	100
40 - 25	735 938 747	0.042	2.4	1.9	100
40 - 32	735 938 746	0.049	2.4	2.4	100
50 - 32	735 938 753	0.066	3.0	2.4	100
50 - 40	735 938 752	0.069	3.0	2.4	100
63 - 32	735 938 760	0.083	3.0	2.4	100
63 - 40	735 938 759	0.084	3.0	2.4	100
63 - 50	735 938 758	0.096	3.0	3.0	100

Restraint Fitting, PN 16, PVDF-HP

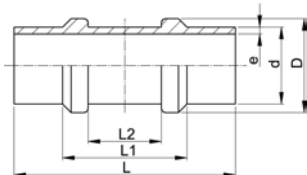

d [mm]	PN	Code	kg	D [mm]	e [mm]	L [mm]	L1 [mm]	L2 [mm]
20	16	735 918 656	0.027	28	1.9	100	53	32
25	16	735 918 657	0.036	33	1.9	100	53	32
32	16	735 918 658	0.054	40	2.4	100	53	32
40	16	735 918 659	0.067	48	2.4	100	53	32
50	16	735 918 660	0.100	58	3.0	100	53	32
63	16	735 918 661	0.131	71	3.0	105	53	32
75	16	735 918 662	0.252	87	3.6	125	70	40
90	16	735 918 663	0.353	105	4.3	125	70	40
110	16	735 918 664	0.516	127	5.3	125	70	40



Instrument Installation Fitting, PN 16, PVDF-HP

Model:

- Suitable for hole diameters from 1/4" - 3/4"
- Injection-moulded version

Note:

- Hole needs to be milled, HAND HELD DRILLING MUST NOT BE DONE

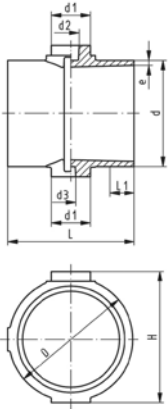

d [mm]	PN	Code	kg	D [mm]	e [mm]	d1 [mm]	d2 [mm]	H [mm]	L [mm]	L1 [mm]
63	16	735 918 811	0.235	85	3.0	40	17	89	120	25
75	16	735 918 812	0.326	96	3.6	40	17	101	130	25
90	16	735 918 813	0.418	110	4.3	40	17	116	130	25
110	16	735 918 814	0.561	127	5.3	40	17	136	130	25



Instrument Installation Fitting, PN 16, PVDF-HP

Model:

- Suitable for hole diameters from 1/8" - 3/4"
- Machined version

Note:

- Hole needs to be milled, HAND HELD DRILLING MUST NOT BE DONE

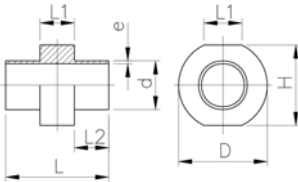

* no stock item

d [mm]	PN	Code	kg	D [mm]	e [mm]	H [mm]	L [mm]	L1 [mm]	L2 [mm]
*63	16	735 918 611	0.495	105	3.0	97	100	40	27
*75	16	735 918 612	0.554	115	3.6	108	90	40	22
*90	16	735 918 613	0.649	128	4.3	121	90	40	22
*110	16	735 918 614	0.778	145	5.3	139	90	40	22
*125	16	735 918 615	1.007	162	6.0	157	100	40	27
*140	16	735 918 616	1.185	176	6.7	171	110	40	32
*160	16	735 918 617	1.405	194	7.7	190	110	40	32
*200	16	735 918 619	1.871	231	9.6	228	110	40	32
*225	16	735 918 620	2.284	254	10.8	251	110	40	32



Instrument Installation Fitting, PN 10, PVDF-HP

Model:

- Suitable for hole diameters from 1/8" - 3/4"
- Machined version

Note:

- Hole needs to be milled, HAND HELD DRILLING MUST NOT BE DONE

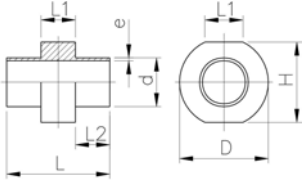

d [mm]	PN	Code	kg	D [mm]	e [mm]	H [mm]	L [mm]	L1 [mm]	L2 [mm]
125	10	735 918 565	0.858	162	3.9	157	100	40	27
140	10	735 918 566	1.003	176	4.4	171	110	40	32
160	10	735 918 567	1.151	194	4.9	190	110	40	32
200	10	735 918 569	1.486	231	6.2	228	110	40	32
225	10	735 918 570	3.151	254	7.0	251	110	40	32

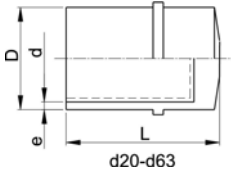

Cap, PVDF-HP

d [mm]	PN	Code	kg	e [mm]	L [mm]
20	16	735 991 651	0.020	1.9	47
25	16	735 991 652	0.028	1.9	48
32	16	735 991 653	0.050	2.4	52
40	16	735 991 654	0.068	2.4	59
50	16	735 991 655	0.107	3.0	64
63	16	735 991 656	0.165	3.0	69
75	16	735 991 657	0.283	3.6	40
90	16	735 991 658	0.509	4.3	40
110	16	735 991 659	0.812	5.3	40
160	10	735 991 661	1.046	4.9	50
200	10	735 991 662	1.637	6.2	50
225	10	735 991 663	2.072	6.9	50

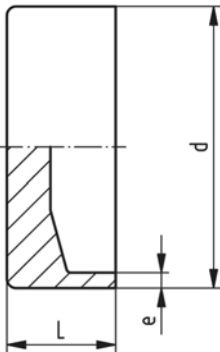

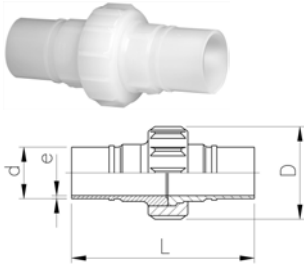

Union (FPM white), PN 16, PVDF-HP

Model:

- FDA compliant
- supplied with sealing
- d75, d90 and d110 with buttress shaped thread
- * version without BCF collar (won't be replaced)

- Please see installation instruction

Note:

- Products, except d75-110, will be replaced in 1. quarter 2007

d [mm]	PN	Code	kg	D [mm]	L [mm]	e [mm]
20	16	735 518 706	0.093	45	137	1.9
25	16	735 518 707	0.130	57	136	1.9
32	16	735 518 708	0.180	62	138	2.4
40	16	735 518 709	0.300	75	176	2.4
50	16	735 518 710	0.419	84	178	3.0
63	16	735 518 711	0.637	101	187	3.0
*75	16	735 528 637	0.740	133	131	3.6
*90	16	735 528 638	0.730	133	131	4.3
*110	16	735 528 639	1.020	155	131	5.3

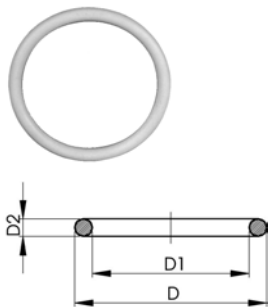

O-Ring, FPM white

- For SYGEF® Plus Union and diaphragm valve SYGEF® Plus type 314

d [mm]	PN	Code	kg	D [mm]	D1 [mm]	D2 [mm]
20	16	749 411 005	0.002	20.7	15.5	2.6
25	16	749 411 006	0.002	27.2	20.2	3.5
32	16	749 411 120	0.002	33.6	26.6	3.6
40	16	749 411 062	0.003	41.6	34.5	3.6
50	16	749 411 172	0.003	51.1	44.0	3.5
63	16	749 411 054	0.005	63.0	55.0	4.0
75	16	749 411 014	0.012	75.5	81.9	5.3
90	16	749 411 015	0.015	90.0	101.0	5.3
110	16	749 411 016	0.031	110.0	120.0	7.0

Transition Fittings

Adaptor Nipple, male thread - R, PN 16, PVDF-HP

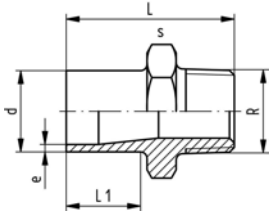

Model:

- With taper male thread
- Connection to plastic thread only
- Do not use thread sealing pastes that are harmful to PVDF
- Avoid stresses when installing and large changes in temperature

d [mm]	R [inch]	PN	Code	kg	e [mm]	L [mm]	s [mm]	L1 [mm]
20	1/2	16	735 910 706	0.020	1.9	53	32	28
25	3/4	16	735 910 707	0.021	1.9	55	36	28
32	1	16	735 910 708	0.034	2.4	57	46	28
40	1 1/4	16	735 910 709	0.058	2.4	60	55	28
50	1 1/2	16	735 910 710	0.087	3.0	63	65	28
63	2	16	735 910 711	0.118	3.0	69	75	29

Adaptor Nipple, male thread - NPT, PN 16, PVDF-HP

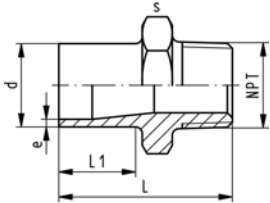

Model:

- With taper male thread
- Connection to plastic thread only
- Do not use thread sealing pastes that are harmful to PVDF
- Avoid stresses when installing and large changes in temperature

d [mm]	NPT [inch]	PN	Code	kg	e [mm]	L [mm]	s [mm]	L1 [mm]
20	1/2	16	735 914 306	0.016	1.9	53	32	28
25	3/4	16	735 914 307	0.021	1.9	55	36	28
32	1	16	735 914 308	0.035	2.4	57	46	28
40	1 1/4	16	735 914 309	0.057	2.4	60	55	28
50	1 1/2	16	735 914 310	0.085	3.0	63	65	28
63	2	16	735 914 311	0.119	3.0	69	75	29

Adaptor Socket, female thread - Rp, PN 16, PVDF-HP

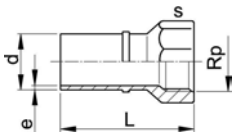

Model:

- With parallel female thread Rp
- Connection to plastic thread only
- Do not use thread sealing pastes that are harmful to PVDF
- Avoid stresses when installing and large changes in temperature

d [mm]	Rp [inch]	PN	Code	kg	e [mm]	L [mm]	s [mm]	L1 [mm]
20	1/2	16	735 910 736	0.020	1.9	58	30	28
25	3/4	16	735 910 737	0.060	1.9	60	35	28
32	1	16	735 910 738	0.090	2.4	65	45	28
40	1 1/4	16	735 910 739	0.130	2.4	85	54	28
50	1 1/2	16	735 910 740	0.170	3.0	85	60	28
63	2	10	735 910 741	0.250	3.0	93	76	29

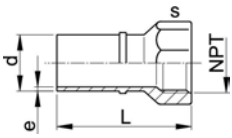

Adaptor Socket, female thread - NPT, PN 16, PVDF-HP

Model:

- Connection to plastic or metal
- Do not use thread sealing pastes that are harmful to PVDF
- Avoid stresses when installing and large changes in temperature

d [mm]	NPT [inch]	PN	Code	kg	e [mm]	L [mm]	s [mm]
25	1/2	16	735 914 406	0.021	1.9	58	30
25	3/4	16	735 914 407	0.028	1.9	60	35
32	1	16	735 914 408	0.049	2.4	65	45
40	1 1/4	16	735 914 409	0.084	2.4	85	54
50	1 1/2	16	735 914 410	0.110	3.0	85	60
63	2	10	735 914 411	0.173	3.0	93	76

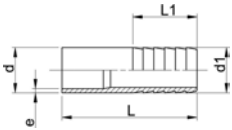

Hose Adapter, PN 16, PVDF-HP

Model:

- With butt fusion spigot

d - d1 [mm]	PN	e [mm]	L [mm]	L1 [mm]	Code	kg
20 - 20	16	1.9	64	27	735 968 731	0.001
25 - 25	16	1.9	75	36	735 968 732	0.001
32 - 32	16	2.4	82	36	735 968 733	0.001
40 - 40	16	2.4	84	42	735 968 734	0.001
50 - 50	16	3.0	90	48	735 968 735	0.150
63 - 60	16	3.0	100	50	735 968 736	0.001

Sanitary Adaptors

Sanitary Adaptor, PN16, PVDF-HP, with stainless reinforcement ferrule ISO 1127

* Model without chamfer

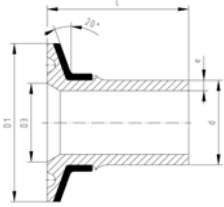

d [mm]	DN [mm]	PN	Code	kg	e [mm]	D1 [mm]	D3 [mm]	L [mm]
20	15	16	735 598 006	0.032	1.9	50.5	18.1	49
25	20	16	735 598 008	0.042	1.9	50.5	23.4	55
25	25	16	735 598 009	0.041	1.9	50.5	29.7	55
32	25	16	735 598 010	0.045	2.4	50.5	29.6	57
40	32	16	735 598 014	0.073	2.4	64.0	34.8	67
*50	40	16	735 598 016	0.083	3.0	64.0	44.0	68
*63	50	16	735 598 018	0.107	3.0	77.5	57.0	71

Sanitary Adaptor, PN16, PVDF-HP, with stainless reinforcement ferrule DIN 32676

* Model without chamfer

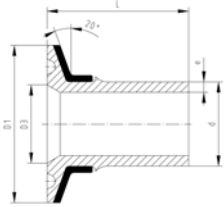

d [mm]	DN [mm]	PN	Code	kg	e [mm]	D1 [mm]	D3 [mm]	L [mm]
*20	15	16	735 598 056	0.020	1.9	34.0	16.2	49
20	20	16	735 598 057	0.020	1.9	34.0	20.0	49
25	25	16	735 598 059	0.042	1.9	50.5	26.0	55
32	32	16	735 598 062	0.045	2.4	50.5	31.7	57
40	40	16	735 598 065	0.047	2.4	50.5	38.0	67
50	50	16	735 598 067	0.081	3.0	64.0	50.0	68

Sanitary Adaptor, PN16, PVDF-HP, with stainless reinforcement ferrule BS 4825 (inch)

* Model without chamfer

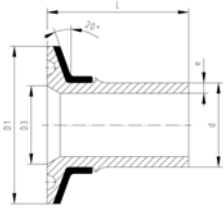

d [mm]	Inch	PN	Code	kg	e [mm]	D1 [mm]	D3 [mm]	L [mm]
20	3/4	16	735 598 157	0.040	1.9	50.5	22.1	49
*25	1	16	735 598 159	0.042	1.9	50.5	22.4	49
32	1 1/2	16	735 598 163	0.044	2.4	50.5	34.9	57
40	1 1/2	16	735 598 165	0.047	2.4	50.5	35.5	67
50	2	16	735 598 167	0.082	3.0	64.0	47.7	68
63	2 1/2	16	735 598 169	0.107	3.0	77.5	59.9	71



Sanitary Adaptor, PN16, PVDF-HP, with stainless reinforcement ferrule 3A Standard

¹ Model without stainless reinforcement

* Model without chamfer

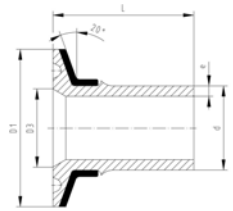

d [mm]	Inch	PN	Code	kg	e [mm]	D1 [mm]	D3 [mm]	L [mm]
*20	3/4	16	735 598 207	0.011	1.9	25.0	16.2	49
*25	1	16	735 598 209	0.042	1.9	50.5	22.4	49
32	1 1/2	16	735 598 213	0.044	2.4	50.5	34.9	57
40	1 1/2	16	735 598 215	0.047	2.4	50.5	35.2	67
50	2	16	735 598 217	0.082	3.0	64.0	47.7	68
63	2 1/2	16	735 598 219	0.107	3.0	77.5	59.9	71



Sanitary Adaptor, PN16, PVDF-HP, with stainless reinforcement DIN 3017

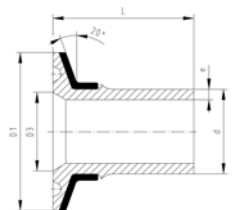

d [mm]	DN [mm]	PN	Code	kg	e [mm]	D1 [mm]	D3 [mm]	L [mm]
25	25	16	735 598 259	0.042	1.9	50.5	22.4	55
32	32	16	735 598 262	0.042	2.4	50.5	31.7	57
40	40	16	735 598 265	0.047	2.4	50.5	35.2	67
50	50	16	735 598 267	0.081	3.0	64.0	48.6	68
63	65	16	735 598 269	0.107	3.0	77.5	59.9	71



Sanitary Adaptor, PN16, PVDF-HP, with stainless reinforcement ISO 2852

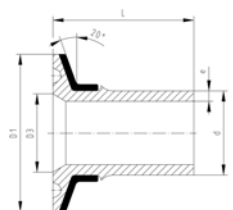

d [mm]	DN [mm]	PN	Code	kg	e [mm]	D1 [mm]	D3 [mm]	L [mm]
25	25	16	735 598 309	0.042	1.9	50.5	22.4	55
32	32	16	735 598 312	0.045	2.4	50.5	31.7	57
40	40	16	735 598 315	0.047	2.4	50.5	35.2	67
50	50	16	735 598 317	0.081	3.0	64.0	48.6	68
63	65	16	735 598 319	0.107	3.0	77.5	59.9	71



Sanitary Adaptor, PN16, PVDF-HP, with stainless reinforcement ASME BPE

¹ Model without stainless reinforcement

* Model without chamfer

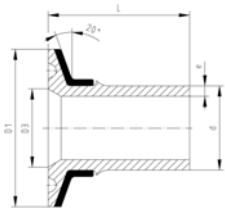

d [mm]	Inch	PN	Code	kg	e [mm]	D1 [mm]	D3 [mm]	L [mm]
¹ 20	¾	16	735 598 357	0.011	1.9	25.0	16.2	49
25	1	16	735 598 359	0.042	1.9	50.5	22.4	55
32	1 ½	16	735 598 362	0.044	2.4	50.5	34.9	57
40	1 ½	16	735 598 365	0.047	2.4	50.5	35.5	57
50	2	16	735 598 367	0.082	3.0	64.0	47.7	68
63	2 ½	16	735 598 369	0.107	3.0	77.5	59.9	71



Sanitary Adaptor, PN16, PVDF-HP, with stainless reinforcement JIS G3447

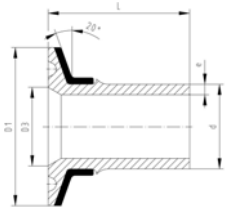

d [mm]	DN [mm]	PN	Code	kg	e [mm]	D1 [mm]	D3 [mm]	L [mm]
20	15	16	735 598 406	0.020	1.9	34.0	17.5	49
25	20	16	735 598 408	0.042	1.9	50.5	23.4	55
32	25	16	735 598 410	0.045	2.4	50.5	29.6	57
40	32	16	735 598 414	0.047	2.4	50.5	35.2	67
50	40	16	735 598 416	0.082	3.0	64.0	47.7	68
63	50	16	735 598 418	0.107	3.0	77.5	59.9	71



Sanitary Adaptor, PN16, PVDF-HP, with stainless reinforcement ferrule for Mebrane Manometer

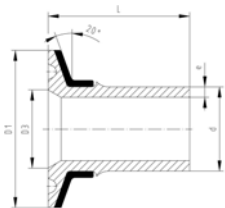

d [mm]	DN [mm]	PN	Code	kg	e [mm]	D1 [mm]	D3 [mm]	L [mm]
20	15	16	735 598 506	0.038	1.9	50.5	34.1	49
25	20	16	735 598 508	0.041	1.9	50.5	34.1	55
32	25	16	735 598 510	0.045	2.4	50.5	34.1	57

Diaphragm valves

SYGEF® PLUS Diaphragm valve type 314 With butt fusion spigots

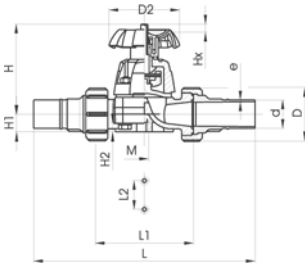

Model:

- Diaphragm PTFE with EPDM backing diaphragm (FDA compliant)
- For easy installation and removal
- Short overall length
- Welding dimension: PN16
-

Option:

- Handwheel with built-in locking mechanism (standard version is nonlockable)

d [mm]	DN [mm]	PN	kv-value ($\Delta p=1$ bar) [l/min]	PTFE/EPDM Code	kg
20	15	10	72	175 314 362	0.500
25	20	10	137	175 314 363	0.725
32	25	10	207	175 314 364	1.000
40	32	10	354	175 314 365	1.600
50	40	10	517	175 314 366	2.092
63	50	10	713	175 314 367	3.619

d [mm]	D [mm]	D2 [mm]	e [mm]	H [mm]	H1 [mm]	H2 [mm]	L [mm]	L1 [mm]	L2 [mm]	M
20	45	80	1.9	90	14	12	225	90	25	M6
25	55	80	1.9	101	18	12	242	108	25	M6
32	62	94	2.4	117	22	12	254	116	25	M6
40	75	117	2.4	127	26	15	308	134	45	M8
50	84	117	3.0	139	32	15	330	154	45	M8
63	101	152	3.0	172	39	15	373	184	45	M8

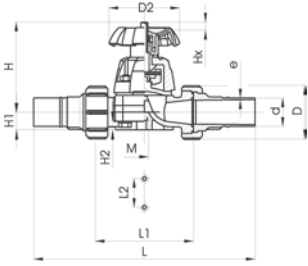

SYGEF® PLUS

Diaphragm valve type 314 HTR

With butt fusion spigots

Model:

- High Temperature Resistant (HTR)
- With additional sealing element FPM white (FDA compliant)
- Diaphragm PTFE with EPDM backing diaphragm (FDA compliant)
- For easy installation and removal
- Short overall length
- Welding dimension: PN16
- Red handwheel
-

d [mm]	DN [mm]	PN	kv-value ($\Delta p=1$ bar) [l/min]	PTFE/EPDM FPM SEALING ELEMENT Code	kg
20	15	10	72	175 314 662	0.500
25	20	10	137	175 314 663	0.725
32	25	10	207	175 314 664	1.000
40	32	10	354	175 314 665	1.600
50	40	10	517	175 314 666	2.092
63	50	10	713	175 314 667	3.619

d [mm]	D [mm]	D2 [mm]	e [mm]	H [mm]	H1 [mm]	H2 [mm]	L [mm]	L1 [mm]	L2 [mm]	M
20	45	80	1.9	90	14	12	225	90	25	M6
25	55	80	1.9	101	18	12	242	108	25	M6
32	62	94	2.4	117	22	12	254	116	25	M6
40	75	117	2.4	127	26	15	308	134	45	M8
50	84	117	3.0	139	32	15	330	154	45	M8
63	101	152	3.0	172	39	15	373	184	45	M8



SYGEF® PLUS

Diaphragm valve type 315

With butt fusion ends metric

Model:

- Diaphragm PTFE with EPDM backing diaphragm (FDA compliant)
- Welding dimension: PN16

Option:

- Handwheel with built-in locking mechanism (standard version is nonlockable)

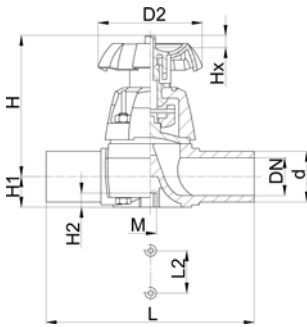

d [mm]	DN [mm]	PN	kv-value ($\Delta p=1$ bar) [l/min]	PTFE with EPDM supp. diaphragm Code	kg	D2 [mm]	H [mm]	H1 [mm]	H2 [mm]	L [mm]	L2 [mm]	M
20	15	10	72	175 315 562	0.360	80	90	14	12	124	25	M6
25	20	10	137	175 315 563	0.560	80	102	18	12	144	25	M6
32	25	10	207	175 315 564	0.804	94	119	21	12	154	25	M6
40	32	10	354	175 315 565	1.025	117	126	26	15	174	45	M8
50	40	10	517	175 315 566	1.480	117	139	33	15	194	45	M8
63	50	10	713	175 315 567	2.581	152	172	39	15	224	45	M8
75	65	10	992	175 315 368	4.343	152	210	46	15	214	70	M8

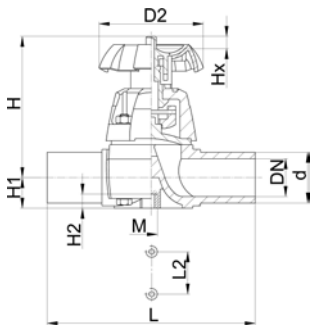

SYGEF® PLUS

Diaphragm valve type 315 HTR

With butt fusion ends metric

Model:

- High Temperature Resistant (HTR)
- Diaphragm PTFE with EPDM backing diaphragm (FDA compliant)
- With additional sealing element FPM white (FDA compliant)
- Welding dimension: PN16
- Further versions: with backing diaphragm FPM on request
- Red handwheel

d [mm]	DN [mm]	PN	kv-value ($\Delta p=1$ bar) [l/min]	PTFE/EPDM FPM SEALING ELEMENT Code	kg	D2 [mm]	H [mm]	H1 [mm]	H2 [mm]	L [mm]	L2 [mm]	M
20	15	10	72	175 315 602	0.360	80	90	14	12	124	25	M6
25	20	10	137	175 315 603	0.560	80	102	18	12	144	25	M6
32	25	10	207	175 315 604	0.804	94	119	21	12	154	25	M6
40	32	10	354	175 315 605	1.025	117	126	26	15	174	45	M8
50	40	10	517	175 315 606	1.480	117	139	33	15	194	45	M8
63	50	10	713	175 315 607	2.581	152	172	39	15	224	45	M8



SYGEF® PLUS

Diaphragm valve type 317

Flanged connection metric

Model:

- DN 15-65 with backing flange
- DN 80-150 with fixed flange
- Overall length according to EN 558-1
- Diaphragm PTFE with EPDM backing diaphragm (FDA compliant)

Option:

- Handwheel with built-in locking mechanism (standard version is nonlockable)

* DN80 and DN150 fixed flanges metric and Inch ANSI B16.5

d [mm]	DN [mm]	Inch	PN	kv-value ($\Delta p=1$ bar) [l/min]	PTFE/EPDM Code	kg
20	15	½	10	72	175 317 447	0.580
25	20	¾	10	137	175 317 448	0.858
32	25	1	10	207	175 317 449	1.205
40	32	1 ¼	10	354	175 317 450	2.270
50	40	1 ½	10	517	175 317 451	2.260
63	50	2	10	713	175 317 452	3.700
75	65	2 ½	10	992	175 317 453	5.700
*90	80	3	10	1700	175 317 054	10.700
110	100	4	10	2700	175 317 055	14.890
*160	150	6	7	6033	175 317 057	31.000

d [mm]	D [mm]	D1 [mm]	D2 [mm]	D3 [mm]	H [mm]	H1 [mm]	H2 [mm]	L [mm]	L1 [mm]	L2 [mm]	L3 [mm]	M	AL
20	95	65	80	14	90	14	12	130		25		M6	4
25	105	75	80	14	102	18	12	150		25		M6	4
32	115	85	94	14	119	21	12	160		25		M6	4
40	140	100	117	18	126	26	15	180		45		M8	4
50	150	110	117	18	139	33	15	200		45		M8	4
63	165	125	152	18	172	39	15	230		45		M8	4
75	185	145	152	18	201	46	15	290		70		M8	4
*90	200	152	270	18	265	57	23	310	35	120		M12	8
110	225	180	270	18	302	68	23	350	35	120		M12	8
*160	285	240	400	22	437	108	23	480	26	100	200	M12	8

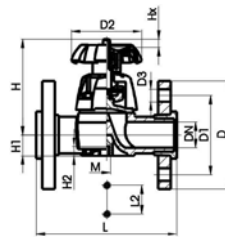

DN 15-65

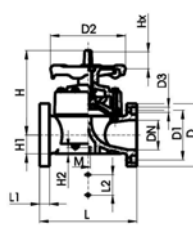

DN 80-100

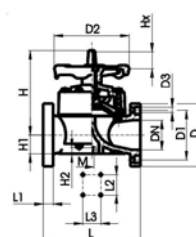

DN 150



SYGEF® PLUS Diaphragm valve type 317 Flanged version ANSI

Model:

- DN 15-65 with backing flange
- DN 80-150 with fixed flange
- Overall length according to EN 558-1
- Diaphragm PTFE with EPDM backing diaphragm (FDA compliant)

Option:

- Handwheel with built-in locking mechanism (standard version is nonlockable)

* DN80 and DN150 fixed flanges metric and Inch ANSI B16.5

d [mm]	DN [mm]	Inch	PN	kv-value ($\Delta p=1$ bar) [l/min]	PTFE with EPDM supp. Diaphragm Code	kg
20	15	½	10	72	175 317 562	0.760
25	20	¾	10	137	175 317 563	1.210
32	25	1	10	207	175 317 564	1.620
40	32	1 ¼	10	354	175 317 565	2.270
50	40	1 ½	10	517	175 317 566	2.810
63	50	2	10	713	175 317 567	4.230
75	65	2 ½	10	992	175 317 568	5.700
*90	80	3	10	1700	175 317 054	10.700
110	100	4	10	2700	175 317 355	14.950

d [mm]	D [mm]	D1 [mm]	D2 [mm]	D3 [mm]	H [mm]	H1 [mm]	H2 [mm]	L [mm]	L1 [mm]	L2 [mm]	M	AL
20	95	61	80	14	90	14	12	130		25	M6	4
25	105	70	80	14	93	18	12	150		25	M6	4
32	115	80	94	14	119	21	12	160		25	M6	4
40	140	89	117	18	126	26	15	180		45	M8	4
50	150	99	117	18	139	33	15	200		45	M8	4
63	165	121	152	18	172	39	15	230		45	M8	4
75	185	140	152	18	201	46	15	290		70	M8	4
*90	200	152	270	18	265	57	23	310	35	120	M12	8
110	225	191	270	18	302	68	23	350	35	120	M12	8

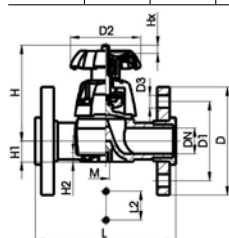

DN 15-65

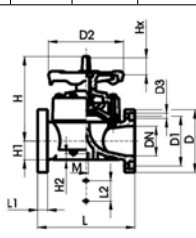

DN 80-100

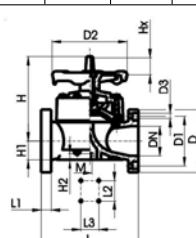

DN 150



SYGEF® PLUS

Diaphragm valve type 319

With butt fusion spigots

Model:

- Diaphragm PTFE with EPDM backing diaphragm (FDA compliant)
- Welding dimension: PN16

Option:

- Handwheel with built-in locking mechanism (standard version is nonlockable)

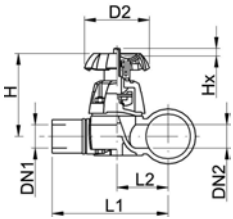
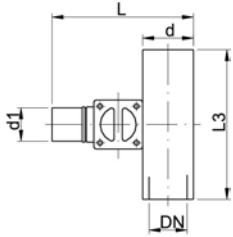

d [mm]	d1 [mm]	DN [mm]	DN1 [mm]	DN2 [mm]	PN	kv-value ($\Delta p=1$ bar) [l/min]	PTFE/EPDM Code	kg
20	20	15	15	15	10	47	175 319 301	0.366
25	20	20	15	20	10	69	175 319 303	0.546
25	25	20	20	20	10	91	175 319 304	0.548
32	20	25	15	25	10	86	175 319 307	0.759
32	25	25	20	25	10	126	175 319 308	0.756
32	32	25	25	25	10	156	175 319 309	0.754
40	20	32	15	25	10	84	175 319 312	0.449
40	25	32	20	25	10	124	175 319 313	0.810
40	32	32	25	25	10	161	175 319 314	0.810
40	40	32	32	32	10	250	175 319 315	1.210
50	20	40	15	25	10	82	175 319 318	0.873
50	25	40	20	25	10	124	175 319 319	0.934
50	32	40	25	25	10	159	175 319 320	0.868
50	40	40	32	40	10	312	175 319 321	1.685
50	50	40	40	40	10	356	175 319 322	1.680
63	20	50	15	25	10	81	175 319 325	0.937
63	25	50	20	25	10	115	175 319 326	0.934
63	32	50	25	25	10	156	175 319 327	0.932
63	40	50	32	50	10	383	175 319 328	2.635
63	50	50	40	50	10	487	175 319 329	2.610
63	63	50	50	50	10	544	175 319 330	2.615
75	40	65	32	32	10	256	175 319 336	1.320
75	50	65	40	50	10	497	175 319 337	2.710
75	63	65	50	50	10	546	175 319 338	2.710
90	20	80	15	25	10	88	175 319 341	1.178
90	25	80	20	25	10	133	175 319 342	1.176
90	32	80	25	25	10	162	175 319 343	1.172
90	50	80	40	50	10	504	175 319 345	2.968
90	63	80	50	50	10	530	175 319 346	2.968
110	20	100	15	25	10	89	175 319 351	1.288
110	25	100	20	25	10	123	175 319 352	1.286
110	32	100	25	25	10	159	175 319 353	1.283
110	50	100	50	50	10	503	175 319 355	3.258
110	63	100	50	50	10	543	175 319 356	3.250

d [mm]	Lift = Hx [mm]	D2 [mm]	H [mm]	L [mm]	L1 [mm]	L2 [mm]	L3 [mm]
20	8	80	87	106	96	30	140
25	11	80	101	121	108	36	150
25	11	80	101	121	108	36	150
32	13	94	119	137	120	43	160
32	13	94	119	137	120	43	160
32	13	94	119	137	120	43	160
40	12	94	116	149	128	51	180
40	12	94	116	149	128	51	180
40	12	94	116	149	128	51	180
40	16	117	127	174	153	56	190
50	8	94	116	159	134	57	180
50	13	94	119	159	134	57	180

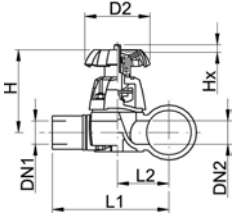
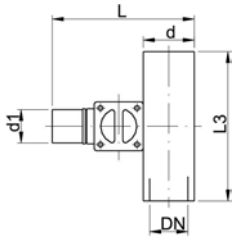

d [mm]	Lift = Hx [mm]	D2 [mm]	H [mm]	L [mm]	L1 [mm]	L2 [mm]	L3 [mm]	
50	13	94	119	159	134	57	180	
50	19	117	139	195	169	66	200	
50	19	117	139	195	169	66	200	
63	13	94	116	175	144	67	180	
63	13	94	116	175	144	67	180	
63	13	94	119	175	144	67	180	
63	27	152	172	223	192	80	220	
63	28	152	172	225	192	80	220	
63	27	152	172	223	192	80	220	
75	16	117	126	203	166	78	190	
75	27	152	172	236	198	86	220	
75	27	152	172	236	198	86	220	
90	13	94	119	204	159	82	160	
90	13	94	119	204	159	82	160	
90	13	94	119	204	159	82	160	
90	28	152	172	252	207	95	220	
90	28	152	172	252	207	95	220	
110	13	94	116	226	171	94	160	
110	13	94	116	226	171	94	160	
110	13	94	116	226	171	94	160	
110	28	152	172	274	219	107	220	
110	28	152	172	274	219	107	220	



SYGEF® PLUS

Diaphragm valve type 319

With butt fusion spigots

Model:

- High Temperature Resistant (HTR)
- Diaphragm PTFE with EPDM backing diaphragm (FDA compliant)
- Suitable for butt and BCF® fusion
- Welding dimension: PN16
- With additional sealing element FPM white (FDA compliant)
- Red handwheel
-

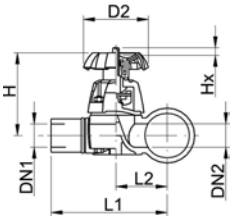
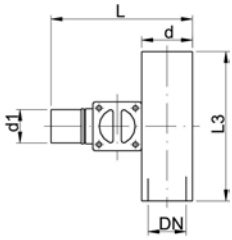

d [mm]	d1 [mm]	DN [mm]	DN1 [mm]	DN2 [mm]	PN	kv-value ($\Delta p=1$ bar) [l/min]	WITH PTFE/EPDM FPM SEALING ELEMENT Code	kg
20	20	15	15	15	10	47	175 319 601	0.366
25	20	20	15	20	10	69	175 319 603	0.546
25	25	20	20	20	10	91	175 319 604	0.548
32	20	25	15	25	10	86	175 319 607	0.759
32	25	25	20	25	10	126	175 319 608	0.756
32	32	25	25	25	10	156	175 319 609	0.754
40	20	32	15	25	10	84	175 319 612	0.449
40	25	32	20	25	10	124	175 319 613	0.810
40	32	32	25	25	10	161	175 319 614	0.810
40	40	32	32	32	10	250	175 319 615	1.210
50	20	40	15	25	10	82	175 319 618	0.873
50	25	40	20	25	10	124	175 319 619	0.872
50	32	40	25	25	10	159	175 319 620	0.868
50	40	40	32	40	10	312	175 319 621	1.685
50	50	40	40	40	10	356	175 319 622	1.680
63	20	50	15	25	10	81	175 319 625	0.937
63	25	50	20	25	10	115	175 319 626	0.934
63	32	50	25	25	10	156	175 319 627	0.932
63	40	50	32	50	10	383	175 319 628	2.635
63	50	50	40	50	10	487	175 319 629	2.610
63	63	50	50	50	10	544	175 319 630	2.615
75	40	65	32	32	10	256	175 319 636	1.320
75	50	65	40	50	10	497	175 319 637	2.710
75	63	65	50	50	10	546	175 319 638	2.710
90	20	80	15	25	10	88	175 319 641	1.178
90	25	80	20	25	10	133	175 319 642	1.176
90	32	80	25	25	10	162	175 319 643	1.172
90	50	80	40	50	10	504	175 319 645	2.968
90	63	80	50	50	10	530	175 319 646	2.968
110	20	100	15	25	10	89	175 319 651	1.288
110	25	100	20	25	10	123	175 319 652	1.286
110	32	100	25	25	10	159	175 319 653	1.283
110	50	100	40	50	10	503	175 319 655	3.258
110	63	100	50	50	10	543	175 319 656	3.250

d [mm]	Lift = Hx [mm]	D2 [mm]	H [mm]	L [mm]	L1 [mm]	L2 [mm]	L3 [mm]
20	8	80	87	106	96	30	140
25	11	80	101	121	108	36	150
25	11	80	101	121	108	36	150
32	13	94	119	137	120	43	160
32	13	94	119	137	120	43	160
32	13	94	119	137	120	43	160
40	12	94	116	149	128	51	180
40	12	94	116	149	128	51	180
40	12	94	116	149	128	51	180

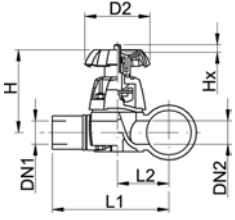
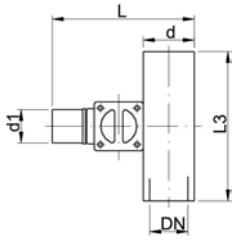

d [mm]	Lift = Hx [mm]	D2 [mm]	H [mm]	L [mm]	L1 [mm]	L2 [mm]	L3 [mm]
40	16	117	127	174	153	56	190
50	8	94	116	159	134	57	180
50	13	94	119	159	134	57	180
50	13	94	119	159	134	57	180
50	19	117	139	195	169	66	200
50	19	117	139	195	169	66	200
63	13	94	116	175	144	67	180
63	13	94	116	175	144	67	180
63	13	94	119	175	144	67	180
63	27	152	172	223	192	80	220
63	28	152	172	225	192	80	220
63	27	152	172	223	192	80	220
75	16	117	126	203	166	78	190
75	27	152	172	236	198	86	220
75	27	152	172	236	198	86	220
90	13	94	119	204	159	82	160
90	13	94	119	204	159	82	160
90	13	94	119	204	159	82	160
90	28	152	172	252	207	95	220
90	28	152	172	252	207	95	220
110	13	94	116	226	171	94	160
110	13	94	116	226	171	94	160
110	13	94	116	226	171	94	160
110	28	152	172	274	219	107	220
110	28	152	172	274	219	107	220

SYGEF® Exhaust

	Page
 Pipe	134
Fittings	135
Flanges	138
Gaskets	139
 Welding Rods	140
Flexible Connection	141

Pipe

Pipe, PVDF (Exhaust)

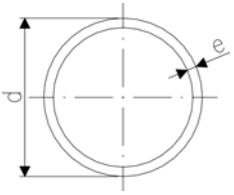

d [mm]	Code	e [mm]	Weight [kg/m]	Length [m]	
75	175 483 459	3.0	1.310	5.00	
110	175 483 461	3.0	1.940	5.00	
160	175 483 464	3.0	2.850	5.00	
200	175 483 466	3.0	3.580	5.00	
250	175 483 468	3.0	4.480	5.00	
315	175 483 470	4.0	7.470	5.00	
400	175 483 472	5.0	11.800	5.00	

Fittings

Bend 90°, PVDF (Exhaust)

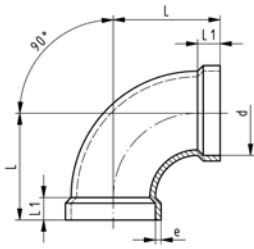

Model:

- for conventional hot gas back welding according to DVS 2207 part 3

d [mm]	Code	kg	e [mm]	L [mm]	L1 [mm]
75	735 550 112	0.220	3.0	115	40
110	735 550 114	0.520	3.0	150	40
160	735 550 117	1.060	3.0	200	40
200	735 550 119	1.600	3.0	240	40
250	735 550 121	3.030	3.5	290	40
315	735 550 123	4.000	4.0	365	50
400	735 550 125	7.400	4.5	450	50

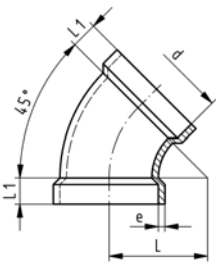

Bend 45°, PVDF (Exhaust)

Model:

- for conventional hot gas back welding according to DVS 2207 part 3

d [mm]	Code	kg	e [mm]	L [mm]	L1 [mm]
75	735 550 212	0.200	3.0	75	40
110	735 550 214	0.370	3.0	110	40
160	735 550 217	0.700	3.0	160	40
200	735 550 219	1.000	3.0	200	40
250	735 550 221	1.770	3.5	250	40
315	735 550 223	2.520	4.0	315	50
400	735 550 225	4.520	4.5	400	50

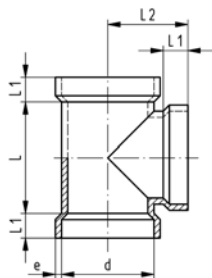

T 90° equal, PVDF (Exhaust)

Model:

- for conventional hot gas back welding according to DVS 2207 part 3

d [mm]	Code	kg	e [mm]	L [mm]	L1 [mm]	L2 [mm]
75	735 550 312	0.320	3.0	105	40	92.5
110	735 550 314	0.520	3.0	140	40	110.0
160	735 550 317	0.880	3.0	190	40	135.0
200	735 550 319	1.300	3.0	230	40	155.0
250	735 550 321	2.310	3.0	290	40	180.0
315	735 550 323	4.370	4.0	370	50	222.5
400	735 550 325	7.600	5.0	440	50	265.0

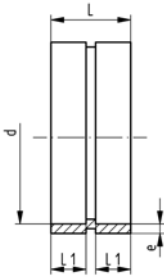

Socket equal, PVDF (Exhaust)

Model:

- for conventional hot gas back welding according to DVS 2207 part 3

d [mm]	Code	kg	e [mm]	L [mm]	L1 [mm]
75	735 550 512	0.180	3.0	120	40
110	735 550 514	0.230	3.0	110	40
160	735 550 517	0.340	3.0	110	40
200	735 550 519	0.450	3.0	110	40
250	735 550 521	0.660	3.5	110	40
315	735 550 523	1.120	4.0	140	50
400	735 550 525	1.630	4.5	140	50

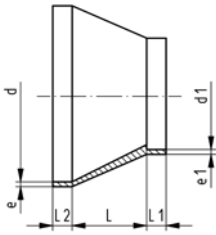

Reducer, PVDF (Exhaust)

Model:

- for conventional hot gas back welding according to DVS 2207 part 3

d - d1 [mm]	Code	kg	L [mm]	L1 [mm]	L2 [mm]
110 - 75	735 550 814	0.280	80	40	40
160 - 110	735 550 817	0.600	140	40	40
200 - 160	735 550 819	0.760	120	40	40
250 - 200	735 550 821	1.140	140	40	40
315 - 250	735 550 823	1.570	100	40	50
400 - 315	735 550 825	2.350	120	50	50

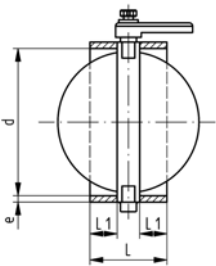

Damper, PVDF (Exhaust)

Model:

- for conventional hot gas back welding according to DVS 2207 part 3

d [mm]	Code	kg	e [mm]	L [mm]	L1 [mm]
75	735 550 412	0.400	3.0	160	40
110	735 550 414	0.510	3.0	150	40
160	735 550 417	0.760	3.0	150	40
200	735 550 419	0.990	3.5	150	40
250	735 550 421	1.420	3.5	150	40
315	735 550 423	2.270	4.0	180	50
400	735 550 425	3.280	4.5	180	50

Flange Adaptor, jointing face serrated, PVDF-Standard

Model:

- for conventional hot gas back welding according to DVS 2207 part 3
- from SYGEF® Standard butt fusion line

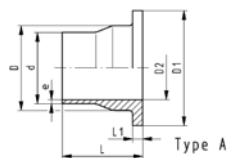
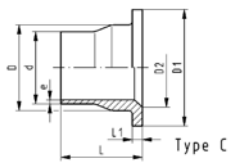

d [mm]	Code	kg	D [mm]	D1 [mm]	D2 [mm]	e [mm]	L [mm]	L1 [mm]	Type
75	735 798 812	0.298	89	122	66	3.6	80	10	A
110	735 798 864	0.450	125	158	100	3.4	81	13	A
160	735 798 867	1.000	175	212	151	4.9	93	17	C
200	735 798 869	1.700	232	268	203	6.2	102	22	C

Flanges

Fix Flange, PVDF (Exhaust)

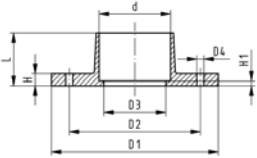

Model:

- for conventional hot gas back welding according to DVS 2207 part 3

d [mm]	Code	kg	L [mm]	D1 [mm]	D2 [mm]	D3 [mm]	D4 [mm]	AL	H [mm]	H1 [mm]
75	735 550 612	0.160	29	140	110	69	10	8	8	3
110	735 550 614	0.200	30	170	150	104	10	8	8	3
160	735 550 617	0.310	30	230	200	154	10	8	8	3
200	735 550 619	0.380	30	270	240	194	10	8	8	3
250	735 550 621	0.440	30	320	290	244	10	12	8	3
315	735 550 623	0.780	30	395	350	307	10	12	12	3
400	735 550 625	0.940	30	475	445	390	10	16	12	3

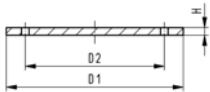

Blind Flange, PVDF (Exhaust)

Model:

- for conventional hot gas back welding according to DVS 2207 part 3

d [mm]	Code	kg	D1 [mm]	D2 [mm]	AL	H [mm]
75	735 550 712	0.220	140	110	8	8
110	735 550 714	0.320	170	150	8	8
160	735 550 717	0.590	230	200	8	8
200	735 550 719	0.810	270	240	8	8
250	735 550 721	1.120	320	290	12	8
315	735 550 723	1.720	395	350	12	10
400	735 550 725	2.470	475	445	16	10

Gaskets

FPM Gasket (Exhaust)

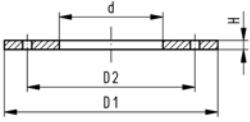

d [mm]	Code	kg	D1 [mm]	D2 [mm]
75	749 400 112	0.060	140	110
110	749 400 114	0.080	170	150
160	749 400 117	0.130	230	200
200	749 400 119	0.160	270	240
250	749 400 121	0.180	320	290
315	749 400 123	0.210	395	350
400	749 400 125	0.310	445	475

Welding Rods

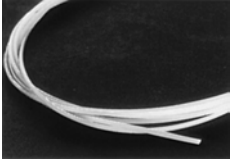

Welding Rod

- Extruded
- Minimum quantity to be ordered : 1kg

Dimension [mm]	Cross-section	Length	Code	kg	Weight	
4	O	coiled	175 480 319	-	1 kg = 45 m	

Flexible Connection

Corrugated tube - Clip Viton

Model:







- Length of tube: ~ 1-1.5 m
- to be fixed connected with pipe on using clamps

Note:

- for flexible tool connection

d [mm]	tube Code	clamp Code	kg	
75	735 550 912	735 550 012	0.010	
110	735 550 914	735 550 014	0.020	
160	735 550 917	735 550 017	0.030	
200	735 550 919	735 550 019	0.060	
250	735 550 921	735 550 021	0.080	

SYGEF Exhaust Accessories

		Page
	Backing Flange, PP-V	144
	Backing Flanges, PP/Steel	147
	Fixed Flange PVDF	150
	Seals	151
	Seals SF	153
	Pipe Clips metric	155

Backing Flange, PP-V

Backing Flanges, PP-V for Butt Fusion Systems metric

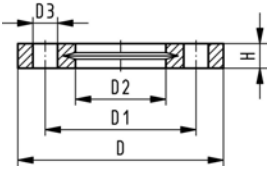
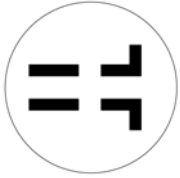

Model:

- Modern full-plastic flange PP-GF (30 % glass-fibre reinforced)
- With V-groove which applies force evenly on collar
- With integrated bolt retainers as an assembly aid
- Connecting dimension: ISO 7005 PN 10, EN 1092 PN 10, DIN 2501 PN 10, BS 4504 PN 10

¹⁾ Suitable for socket- and butt fusion systems (no pictograph on flange)

d [mm]	Inch	DN [mm]	PN	Code	SP	kg	D [mm]	D1 [mm]	D2 [mm]	D3 [mm]	H [mm]	AL	SC
20		15	16	727 700 406	-	0.080	95	65	28	14	16	4	M12
25		20	16	727 700 407	-	0.100	105	75	34	14	17	4	M12
32		25	16	727 700 408	-	0.140	115	85	42	14	18	4	M12
40		32	16	727 700 409	-	0.220	140	100	51	18	20	4	M16
50		40	16	727 700 410	-	0.210	150	110	62	18	22	4	M16
63		50	16	727 700 411	-	0.380	165	125	78	18	24	4	M16
75		65	16	727 700 412	-	0.480	185	145	92	18	26	4	M16
90		80	16	727 700 513	-	0.520	200	160	108	18	27	8	M16
110		100	16	727 700 514	-	0.680	220	180	128	18	28	8	M16
125		100	16	727 700 515	-	0.760	220	180	135	18	28	8	M16
140		125	16	727 700 516	-	0.800	250	210	158	18	30	8	M16
160	6	150	16	727 700 517	-	1.200	285	241	178	22	32	8	M20
180		150	16	727 700 518	-	1.200	285	240	188	22	32	8	M20
200	8	200	16	727 700 519	-	1.400	340	295	235	22	34	8	M20
225	9	200	16	727 700 520	-	1.400	340	295	238	22	34	8	M20
250		250	16	727 700 521	-	1.700	395	350	288	22	38	12	M20
280		250	16	727 700 522	-	1.700	395	350	294	22	38	12	M20
315		300	16	727 700 523	-	2.400	445	400	338	22	42	12	M20



Backing Flanges, PP-V for Socket Systems metric

Model:

- Modern full-plastic flange PP-GF (30 % glass-fibre reinforced)
- With V-groove which applies force evenly on collar
- With integrated bolt retainers as an assembly aid
- Connecting dimension: ISO 7005 PN 10, EN 1092 PN 10, DIN 2501 PN 10, BS 4504 PN 10



¹⁾ Suitable for socket- and butt fusion systems (no pictograph on flange)

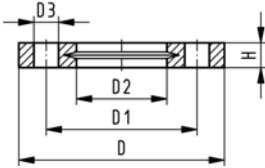

d [mm]	Inch	DN [mm]	PN	Code	kg	D [mm]	D1 [mm]	D2 [mm]	D3 [mm]	H [mm]	AL	SC
'20		15	16	727 700 406	0.080	95	65	28	14	16	4	M12
'25		20	16	727 700 407	0.100	105	75	34	14	17	4	M12
'32		25	16	727 700 408	0.140	115	85	42	14	18	4	M12
'40		32	16	727 700 409	0.220	140	100	51	18	20	4	M16
'50		40	16	727 700 410	0.210	150	110	62	18	22	4	M16
'63		50	16	727 700 411	0.380	165	125	78	18	24	4	M16
'75		65	16	727 700 412	0.480	185	145	92	18	26	4	M16
90		80	16	727 700 413	0.520	200	160	110	18	27	8	M16
110		100	16	727 700 414	0.680	220	180	133	18	28	8	M16
140		125	16	727 700 416	0.800	250	210	167	18	30	8	M16
160	6	150	16	727 700 417	1.200	285	241	190	22	32	8	M20
200		200	16	727 700 419	1.500	340	296	226	22	34	8	M20
225	9	200	16	727 700 420	1.400	340	295	250	22	34	8	M20
250		250	16	727 700 421	1.700	395	350	277	22	38	12	M20
280		250	16	727 700 422	1.700	395	350	310	22	38	12	M20
315		300	16	727 700 423	2.400	445	400	348	22	42	12	M20



Backing Flanges, PP-V for Butt Fusion Systems Inch/ANSI

Model:

- Modern full-plastic flange PP-GF (30 % glass-fibre reinforced)
- With V-groove which applies force evenly on collar
- With integrated bolt-fixing as an assembly aid
- Connection dimensions according to ASME B16.5, ASTM D 4024; bolt circle class 150



¹⁾ Suitable for socket- and butt fusion systems (no pictograph on flange)

Inch	DN [mm]	PN	Code	kg	D [mm]	D1 [mm]	D2 [mm]	D3 [mm]	H [mm]	AL	SC
1/2	15	16	727 701 406	0.080	95	60	28	16	16	4	M12
3/4	20	16	727 701 407	0.100	105	70	34	16	17	4	M12
1	25	16	727 701 408	0.140	115	79	42	16	18	4	M12
1 1/4	32	16	727 701 409	0.220	140	89	51	16	20	4	M16
1 1/2	40	16	727 701 410	0.210	150	98	62	16	22	4	M16
2	50	16	727 701 411	0.380	165	121	78	19	24	4	M16
2 1/2	65	16	727 701 412	0.480	185	140	92	19	26	4	M16
3	80	16	727 701 513	0.520	200	152	108	19	27	4	M16
4	100	16	727 701 514	0.680	229	190	128	19	28	8	M16
6	150	16	727 700 517	1.200	285	241	178	22	32	8	M20
8	200	16	727 700 519	1.400	340	295	235	22	34	8	M20
9	200	16	727 700 520	1.400	340	295	238	22	34	8	M20
10	250	16	727 701 521	1.800	406	362	288	26	38	12	M20
10	250	16	727 701 522	1.700	406	362	294	26	38	12	M20
12	300	16	727 701 523	2.400	483	432	338	26	42	12	M20

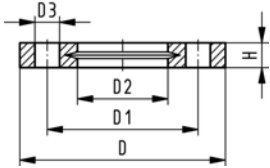

Backing Flanges, PP-V for Socket Systems Inch/ANSI

Model:

- Modern full-plastic flange PP-GF (30 % glass-fibre reinforced)
- With V-groove which applies force evenly on collar
- With integrated bolt-fixing as an assembly aid
- Connection dimensions according to ASME B16.5, ASTM D 4024; bolt circle class 150



¹⁾ Suitable for socket- and butt fusion systems (no pictograph on flange)

Inch	DN [mm]	PN	Code	kg	D [mm]	D1 [mm]	D2 [mm]	D3 [mm]	H [mm]	AL	SC
1/2	15	16	727 701 406	0.080	95	60	28	16	16	4	M12
3/4	20	16	727 701 407	0.100	105	70	34	16	17	4	M12
1	25	16	727 701 408	0.140	115	79	42	16	18	4	M12
1 1/4	32	16	727 701 409	0.220	140	89	51	16	20	4	M16
1 1/2	40	16	727 701 410	0.210	150	98	62	16	22	4	M16
2	50	16	727 701 411	0.380	165	121	78	19	24	4	M16
2 1/2	65	16	727 701 412	0.480	185	140	92	19	26	4	M16
3	80	16	727 701 413	0.520	200	152	110	19	27	4	M16
4	100	16	727 701 414	0.680	229	190	133	19	28	8	M16
6	150	16	727 700 417	1.200	285	241	190	22	32	8	M20
9	200	16	727 700 420	1.400	340	295	250	22	34	8	M20
10	250	16	727 701 422	1.700	406	362	310	26	38	12	M20
12	300	16	727 701 423	2.400	483	432	348	26	42	12	M20

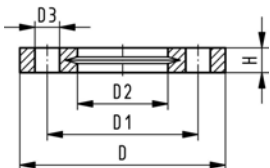

Backing Flanges, PP/Steel

Backing Flanges, PP/Steel for Butt Fusion Systems metric

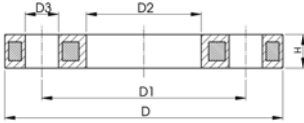

Model:

- Material: PP (30 % glass-fibre reinforced) with steel ring
- Connecting dimensions: ISO 7005 / EN 1092 / DIN 2501 PN10 / BS4504

d [mm]	DN [mm]	PN	Code	D [mm]	D1 [mm]	D2 [mm]	D3 [mm]	H [mm]	AL	SC
20	15	16	727 700 206	95	65	28	14	12	4	M12
25	20	16	727 700 207	105	75	34	14	12	4	M12
32	25	16	727 700 208	115	85	42	14	16	4	M12
40	32	16	727 700 209	140	100	51	18	16	4	M16
50	40	16	727 700 210	150	110	62	18	18	4	M16
63	50	16	727 700 211	165	125	78	18	18	4	M16
75	65	16	727 700 212	185	145	92	18	18	4	M16
90	80	16	727 700 313	200	160	108	18	20	8	M16
110	100	16	727 700 314	220	180	128	18	20	8	M16
125	100	16	727 700 315	220	180	135	18	20	8	M16
140	125	16	727 700 316	250	210	158	18	24	8	M16
160	150	16	727 700 317	285	240	178	22	24	8	M20
180	150	16	727 700 318	285	240	188	22	24	8	M20
200	200	16	727 700 319	340	295	235	22	27	8	M20
225	200	16	727 700 320	340	295	238	22	27	8	M20
250	250	16	727 700 321	395	350	288	22	30	12	M20
280	250	16	727 700 322	395	350	294	22	30	12	M20
315	300	16	727 700 323	445	400	338	22	34	12	M20
355	350	16	727 700 324	515	460	376	23	40	16	M20
400	400	16	727 700 325	574	515	430	26	40	16	M24



Backing Flanges, PP/Steel for Socket Systems metric

Model:

- PP-GF (30% glass-fibre reinforced) with steel ring
- Connecting dimensions: ISO 7005, EN 1092, BS 4504, DIN 2501; bolt circle PN 10

¹ Connecting dimension: ISO 2536 DN125

* Connecting dimension: ISO 2536

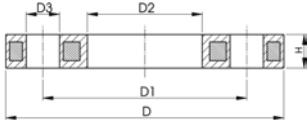

d [mm]	DN [mm]	PN	Code	D [mm]	D1 [mm]	D2 [mm]	D3 [mm]	H [mm]	AL	SC
20	15	16	727 700 206	95	65	28	14	12	4	M12
25	20	16	727 700 207	105	75	34	14	12	4	M12
32	25	16	727 700 208	115	85	42	14	16	4	M12
40	32	16	727 700 209	140	100	51	18	16	4	M16
50	40	16	727 700 210	150	110	62	18	18	4	M16
63	50	16	727 700 211	165	125	78	18	18	4	M16
75	65	16	727 700 212	185	145	92	18	18	4	M16
90	80	16	727 700 213	200	160	110	18	20	8	M16
110	100	16	727 700 214	220	180	133	18	20	8	M16
¹ 125	100	16	727 700 215	250	210	150	18	24	8	M16
140	125	16	727 700 216	250	210	167	18	24	8	M16
160	150	16	727 700 217	285	240	190	22	24	8	M20
200	200	16	727 700 219	340	295	226	22	27	8	M20
225	200	16	727 700 220	340	295	250	22	27	8	M20
250	250	16	727 700 021	395	350	277	22	30	12	M20
*250	250	16	727 700 221	395	325	277	22	30	8	M20
280	250	16	727 700 222	395	350	310	22	30	12	M20
315	300	16	727 700 223	445	400	348	22	34	12	M20
355	350	16	727 700 224	515	460	388	23	40	16	M20
400	400	16	727 700 225	574	515	442	26	40	16	M24



Backing Flanges, PP/Steel for Socket Systems Inch/ANSI

Model:

- For socket systems
- For Flange Adaptors BS (ANSI)
- Material: PP (30 % glass-fibre reinforced) with steel ring
- Connecting dimension ANSI/ASME B 16.5 / ASTM D 4024
- DN100 and DN150: only for use with original metric flange adaptors

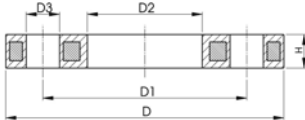

Inch	DN	d	PN	Code	kg	D	D1	D2	D3	H	AL	
	[mm]	[mm]				[mm]	[mm]	[mm]	[mm]	[mm]	[mm]	
1/2	15	20	16	727 701 206	0.210	95	60	28	16	12	4	
3/4	20	25	16	727 701 207	0.250	105	70	34	16	12	4	
1	25	32	16	727 701 208	0.420	115	79	42	16	16	4	
1 1/4	32	40	16	727 701 209	0.670	140	89	51	16	16	4	
1 1/2	40	50	16	727 701 210	0.860	150	98	62	16	18	4	
2	50	63	16	727 701 211	0.930	165	121	78	19	18	4	
2 1/2	65	75	16	727 701 212	1.340	185	140	92	19	18	4	
3	80	90	16	727 701 213	1.550	200	152	110	19	20	4	
4	100	110	16	727 701 214	1.810	229	190	133	19	20	8	
6	150	180	16	727 701 217	3.390	285	241	190	22	24	8	
8	200	200	16	727 701 220	4.410	340	298	250	22	27	8	



Profiled Backing Flanges, PP/Steel for Butt Fusion Systems metric

Model:

- PP with glass-fibre reinforcement and GGG 50 insert
- Connecting dimensions: ISO 7005, EN 1092, DIN 2501
- Bolt circle PN 10

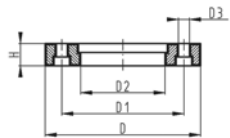

d	DN	PN	Code	kg	D	D1	D2	D3	H	AL	SC	
[mm]	[mm]				[mm]	[mm]	[mm]	[mm]	[mm]	[mm]		
355	350	10	724 700 424	15.570	521	460	376	22	48	16	M20	
400	400	10	724 700 425	19.800	582	515	430	26	51	16	M24	
450	500	10	724 700 426	25.600	684	620	517	26	49	20	M24	
500	500	10	724 700 427	24.300	684	620	533	26	49	20	M24	
560	600	10	724 700 428	35.700	796	725	618	30	58	20	M27	
630	600	10	724 700 429	32.500	796	725	645	30	68	20	M27	



Profiled Backing Flanges, PP/Steel for Butt Fusion Systems metric

Model:

- PP with glass-fibre reinforcement and GGG 50 insert
- Connecting dimensions: ISO 7005, EN 1092, DIN 2501
- Bolt circle PN 16

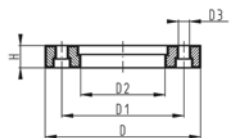

d	DN	PN	Code	kg	D	D1	D2	D3	H	AL	SC	
[mm]	[mm]				[mm]	[mm]	[mm]	[mm]	[mm]	[mm]		
200	200	16	724 700 319	3.720	344	295	235	22	28	12	M20	
225	200	16	724 700 320	3.320	344	295	238	22	28	12	M20	
250	250	16	724 700 321	6.390	405	355	288	26	31	12	M24	
280	250	16	724 700 322	6.310	405	355	294	26	31	12	M24	
315	300	16	724 700 323	9.740	465	410	338	26	38	12	M24	
355	350	16	724 700 324	16.300	532	470	376	26	48	16	M24	
400	400	16	724 700 325	20.600	594	525	430	30	54	16	M27	

Fixed Flange PVDF

Fixed Flanges, socket fusion Jointing face serrated, metric

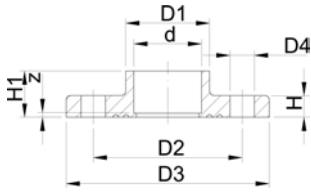

Model:

- With fusion socket metric
- Material: PVDF
- Flange drillings to: ISO / DIN

d [mm]	DN [mm]	Inch	PN	Code	SP	kg
20	15	1/2	16	735 740 106	-	0.137
25	20	3/4	16	735 740 107	-	0.185
32	25	1	16	735 740 108	-	0.255
40	32	1 1/4	16	735 740 109	-	0.402
50	40	1 1/2	16	735 740 110	-	0.486
63	50	2	16	735 740 111	-	0.551

d [mm]	D1 [mm]	D2 [mm]	D3 [mm]	D4 [mm]	H [mm]	H1 [mm]	AL	z [mm]
20	27	65	93	14	12	19	4	5
25	33	75	103	14	13	21	4	4
32	40	85	115	14	14	23	4	4
40	50	100	137	18	15	25	4	4
50	61	110	147	18	16	27	4	4
63	76	125	162	18	18	31	4	4

Fixed Flanges, socket fusion Jointing face flat, metric

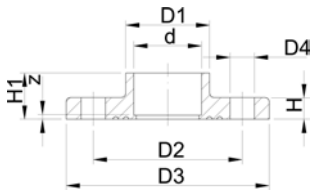

Model:

- With fusion socket metric
- Material: PVDF
- Flange drillings to: ISO / DIN

d [mm]	DN [mm]	Inch	PN	Code	SP	kg
20	15	11/2	16	735 730 106	-	0.137
25	20	13/4	16	735 730 107	-	0.185
32	25	1	16	735 730 108	-	0.255
40	32	1 1/4	16	735 730 109	-	0.355
50	40	1 1/2	16	735 730 110	-	0.486
63	50	2	16	735 730 111	-	0.653

d [mm]	D1 [mm]	D2 [mm]	D3 [mm]	D4 [mm]	H [mm]	H1 [mm]	AL	z [mm]
20	27	65	93	14	12	19	4	5
25	33	75	103	14	13	21	4	5
32	40	85	115	14	14	23	4	5
40	50	100	137	18	15	25	4	5
50	61	110	147	18	16	27	4	5
63	76	125	162	18	18	31	4	5

Seals

O-Ring Gaskets

Model:

- For unions
- Hardness approx. 65° Shore
- EPDM minimum temperature -40°C
- FPM minimum temperature -15°C

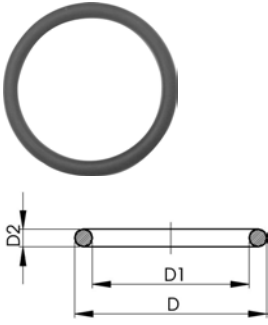

d [mm]	DN [mm]	EPDM Code	FPM Code	SP	kg	D [mm]	D1 [mm]	D2 [mm]
10-12	8	748 410 004	749 410 004	-	0.002	18	12	3
16	10	748 410 005	749 410 005	-	0.002	21	16	3
20	15	748 410 006	749 410 006	-	0.002	27	20	4
25	20	748 410 007	749 410 007	100	0.002	35	28	4
32	25	748 410 008	749 410 008	100	0.002	40	33	4
40	32	748 410 009	749 410 009	-	0.006	51	41	5
50	40	748 410 010	749 410 010	-	0.007	58	47	5
63	50	748 410 011	749 410 011	100	0.010	70	60	5
75	65	748 410 014	749 410 014	100	0.012	93	82	5
90	80	748 410 015	749 410 015	100	0.015	112	101	5
110	100	748 410 016	749 410 016	50	0.031	134	120	7

O-Ring Gaskets

Model:

- For Flange Adaptors
- Hardness approx. 65° Shore

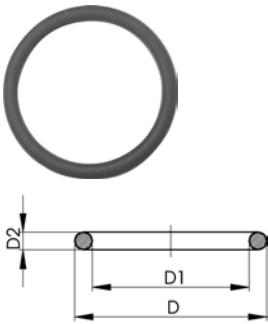

d [mm]	DN [mm]	EPDM Code	FPM Code	SP	kg	D [mm]	D1 [mm]	D2 [mm]
16	10	748 410 000	749 410 000	-	0.002	26	19	4
20	15	748 410 001	749 410 001	100	0.002	31	23	4
25	20	748 410 007	749 410 007	100	0.002	35	28	4
32	25	748 410 002	749 410 002	100	0.003	43	36	4
40	32	748 410 003	749 410 003	-	0.007	55	44	5
50	40	748 410 012	749 410 012	100	0.008	64	53	5
63	50	748 410 013	749 410 013	100	0.011	80	69	5
75	65	748 410 014	749 410 014	100	0.012	93	82	5
90	80	748 410 015	749 410 015	100	0.015	112	101	5
110	100	748 410 016	749 410 016	50	0.031	134	120	7
125	100	748 410 017	749 410 017	200	0.036	150	136	7
140	125	748 410 018	749 410 018	200	0.039	166	152	7
160	150	748 410 019	749 410 019	200	0.047	191	177	7
200	200	748 410 163	749 410 163	-	0.056	236	222	7
225	200	748 410 022	749 410 022	150	0.060	255	241	7
250	250	748 410 182	749 410 182	-	0.003	280	266	7
280	250	748 410 173	749 410 173	-	0.044	306	292	7
315	300	748 410 174	749 410 174	-	0.051	356	342	7

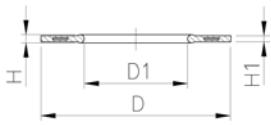

Flange Gaskets for Flange Connections metric

Model:

- Hardness: 70° Shore **EPDM**, 75° Shore **FPM**
- Suitable for flange adaptors

d [mm]	EPDM Code	FPM Code	SP	kg	D [mm]	D1 [mm]	H [mm]	H1 [mm]
20	748 440 101	749 440 101	-	0.008	51	20	4	3
25	748 440 302	749 440 302	-	0.010	61	22	4	3
32	748 440 303	749 440 303	-	0.016	71	28	4	3
40	748 440 304	749 440 304	-	0.025	82	34	4	3
50	748 440 305	749 440 305	-	0.033	92	42	4	3
63	748 440 306	749 440 306	-	0.048	107	53	5	4
75	748 440 307	749 440 307	-	0.076	127	63	5	4
90	748 440 308	749 440 308	-	0.076	142	76	5	4
110	748 440 309	749 440 309	-	0.112	162	93	6	5
125	748 440 310	749 440 310	-	0.110	162	105	6	5
140	748 440 311	749 440 311	-	0.146	192	117	6	5
160	748 440 312	749 440 312	-	0.207	218	135	8	6
180	748 440 313	749 440 313	-	0.260	218	151	8	6
200	748 440 314	749 440 314	-	0.430	273	168	8	6
225	748 440 315	749 440 315	-	0.365	273	188	8	6
250	748 440 316	749 440 316	-	0.520	328	208	8	6
280	748 440 317	749 440 317	-	0.496	328	233	8	6
315	748 440 318	749 440 318	-	0.600	378	262	8	6
355	748 440 319	749 440 319	-	0.750	438	294	8	6
400	748 440 320	749 440 320	-	0.750	489	331	8	6

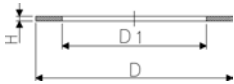

Flat Gaskets

Model:

- Hardness approx. 65° Shore
- For adaptor unions

d [mm]	Inch	EPDM Code	FPM Code	kg	D [mm]	D1 [mm]	H [mm]
12	1/4	748 400 004	-	0.002	20	13	2
16	3/8	748 400 005	749 400 005	0.002	24	17	2
20	1/2	748 400 006	749 400 006	0.003	30	21	3
25	3/4	748 400 007	749 400 007	0.004	38	27	3
32	1	748 400 008	749 400 008	0.002	44	32	3
40	1 1/4	748 400 009	749 400 009	0.003	55	42	3
50	1 1/2	748 400 010	749 400 010	0.004	62	46	3
63	2	748 400 011	749 400 011	0.006	78	60	3
75	2 1/2	748 400 012	749 400 012	0.009	97	75	3
90	3	748 400 013	749 400 013	0.011	109	88	3

Seals SF

O-Ring Gaskets

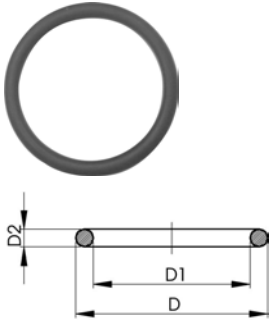

Model:

- Silicon-free / paint-compatible
- Fulfill chloroform contact test
- Hardness approx. 65° Shore
- For flange adaptors, jointing face with O-ring groove
- **Only standard packagings SP are delivered**

d [mm]	DN [mm]	EPDM Code	FPM Code	SP	kg	D [mm]	D1 [mm]	D2 [mm]
20	15	748 413 001	749 413 001	2	0.002	30	23	4
25	20	748 413 007	749 413 007	2	0.002	35	28	4
32	25	748 413 002	749 413 002	2	0.003	43	36	4
40	32	748 413 003	749 413 003	2	0.007	55	44	5
50	40	748 413 012	749 413 012	2	0.008	64	53	5
63	50	748 413 013	749 413 013	2	0.011	80	69	5
75	65	748 413 014	749 413 014	2	0.012	93	82	5
90	80	748 413 015	749 413 015	2	0.015	112	101	5
110	100	748 413 016	749 413 016	2	0.031	134	120	7
125	100	748 413 017	749 413 017	2	0.036	149	136	7
140	125	748 413 018	749 413 018	2	0.039	166	152	7
160	150	748 413 019	749 413 019	2	0.047	191	177	7
200	200	748 413 163	749 413 163	2	0.056	136	222	7
225	200	748 413 022	749 413 022	2	0.060	255	241	7
250	250	748 413 182	749 413 182	2	0.100	280	266	7
280	250	748 413 173	749 413 173	2	0.144	305	292	7

Flange Gaskets SF

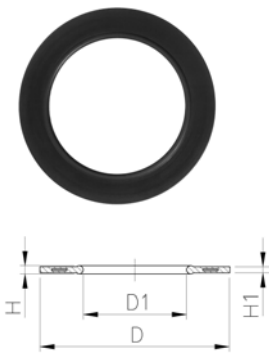

Model:

- Silicon-free / paint-compatible
- Fulfill chloroform contact test
- Hardness: 70° Shore **EPDM**, 75° Shore **FPM**
- For flange adaptors, jointing face flat/serrated

d [mm]	EPDM Code	FPM Code	SP	kg	D [mm]	D1 [mm]	H [mm]	H1 [mm]
20	748 441 101	749 441 101	2	0.008	51	20	4	3
25	748 441 102	749 441 102	2	0.011	61	25	4	3
32	748 441 103	749 441 103	2	0.014	71	32	4	3
40	748 441 104	749 441 104	2	0.020	82	40	4	3
50	748 441 105	749 441 105	2	0.021	92	50	4	3
63	748 441 106	749 441 106	2	0.040	107	63	5	4
75	748 441 107	749 441 107	2	0.054	127	75	5	4
90	748 441 108	749 441 108	2	0.060	142	90	5	4
110	748 441 109	749 441 109	2	0.083	162	110	6	5
125	748 441 110	749 441 110	2	0.154	192	125	6	5
140	748 441 111	749 441 111	2	0.115	192	140	6	5
160	748 441 112	749 441 112	2	0.149	218	160	8	6
200	748 441 114	749 441 114	2	0.257	273	200	8	6
225	748 441 115	749 441 115	2	0.177	273	225	8	6
250	748 441 116	749 441 116	2	0.400	303	250	8	6
280	748 441 117	749 441 117	2	0.220	328	280	8	6



Flat Gaskets

Model:

- Silicon-free / paint-compatible
- Fulfill chloroform contact test
- Hardness approx. 65° Shore
- For flange adaptors, jointing face serrated
- **Only standard packagings SP are delivered**

d [mm]	DN [mm]	FPM Code	SP	kg	D [mm]	D1 [mm]	H [mm]
16	10	-			27	16	2
20	15	749 401 315	2	0.003	32	20	2
25	20	749 401 316	2	0.003	39	25	2
32	25	749 401 317	2	0.004	48	32	2
40	32	749 401 318	2	0.008	59	40	3
50	40	749 401 319	2	0.012	71	50	3
63	50	749 401 320	2	0.017	88	63	3
75	65	749 401 321	2	0.024	104	75	3
90	80	749 401 322	2	0.032	123	90	3
110	100	749 401 323	2	0.062	148	110	4
125	100	749 401 324	2	0.058	168	125	4
140	125	749 401 325	2	0.058	186	140	4
160	150	749 401 326	2	0.063	211	160	4
225	200	749 401 327	2	0.103	272	220	5

Pipe Clips metric

KLIP-IT Pipe Clips Type 061H, PP metric

Model:

- For mm-pipes d16-d63
- Material: PP black, UV resistant
- **Minimum order quantity: standard packagings SP**

- Height designed for Ball Valve Type 546
- * d16 to d32 without bracket

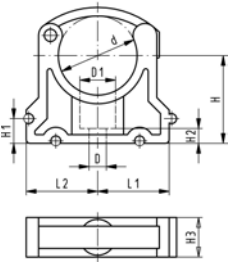

d [mm]	Code	SP	kg	D [mm]	D1 [mm]	L1 [mm]	L2 [mm]	H [mm]	H1 [mm]	H2 [mm]	H3 [mm]	SC
*16	167 061 035	10	0.006	6	11	14	17	27	10	6	16	M5
*20	167 061 036	10	0.008	6	11	17	19	27	10	6	16	M5
*25	167 061 037	10	0.009	6	11	19	22	30	10	6	16	M5
*32	167 061 038	10	0.012	6	11	24	27	36	10	6	16	M5
40	167 061 039	10	0.027	7	14	34	34	44	10	7	22	M6
50	167 061 040	10	0.031	7	14	37	37	51	10	7	22	M6
63	167 061 041	10	0.054	9	17	45	45	64	10	10	25	M8

KLIP-IT Spacer Type 061, PP

Model:

- For pipe clips Type 061/061H, PP black, UV resistant
- **Minimum order quantity: standard packaging SP**

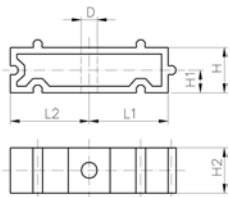

d [mm]	Inch	Code	SP	kg	D [mm]	L1 [mm]	L2 [mm]	H [mm]	H1 [mm]	H2 [mm]	SC
10-12	1/8-1/4	167 061 153	10	0.003	5	11	14	20	10	12	M4
16	3/8	167 061 155	10	0.006	6	14	17	20	10	16	M5
20	1/2	167 061 156	10	0.006	6	17	19	20	10	16	M5
25	3/4	167 061 157	10	0.007	6	19	22	20	10	16	M5
32	1	167 061 158	10	0.008	6	24	27	20	10	16	M5
40	1 1/4	167 061 159	10	0.016	7	34	34	20	10	22	M6
50	1 1/2	167 061 160	10	0.017	7	37	37	20	10	22	M6
63	2	167 061 161	10	0.024	9	45	45	20	10	25	M8
75	2 1/2	167 061 162	10	0.027	9	52	52	20	10	25	M8
90	3	167 061 163	10	0.040	9	65	65	20	10	28	M8
110	4	167 061 164	10	0.048	9	79	79	20	10	28	M8
125	4 1/2	167 061 165	10	0.059	9	88	88	20	10	32	M8
140	5	167 061 166	10	0.065	9	98	98	20	10	32	M8
160	6	167 061 167	10	0.074	9	109	109	20	10	32	M8

KLIP-IT Pipe Clips Type 061, PE metric



Model:

- For mm pipes
- Material: Clip PE and safety clip PP black
- **Minimum order quantity: standard packaging SP**

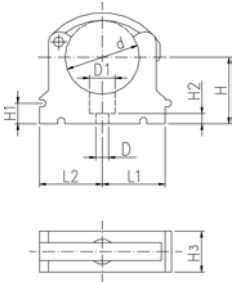

d [mm]	Code	SP	kg	D [mm]	D1 [mm]	L1 [mm]	L2 [mm]	H [mm]	H1 [mm]	H2 [mm]	H3 [mm]	SC
*10	173 061 003	10	0.003	5	8	11	14	20	10	6	12	M4
*12	173 061 004	10	0.006	5	8	11	14	21	10	6	12	M5
*16	173 061 005	10	0.007	6	11	14	17	23	10	6	16	M5
*20	173 061 006	10	0.008	6	11	17	19	25	10	6	16	M5
*25	173 061 007	10	0.009	6	11	19	22	28	10	6	16	M5
*32	173 061 008	10	0.012	6	11	24	27	31	10	6	16	M5
40	173 061 009	10	0.022	7	14	34	34	35	10	7	22	M6
50	173 061 010	10	0.030	7	14	37	37	40	10	7	22	M6
63	173 061 011	10	0.044	9	17	45	45	52	10	10	25	M8
75	173 061 012	10	0.062	9	17	52	52	58	10	10	25	M8
90	173 061 013	10	0.090	9	17	65	65	65	10	10	28	M8
110	173 061 014	10	0.114	9	17	79	79	75	10	10	28	M8
125	173 061 015	10	0.174	9	17	88	88	90	10	10	32	M8
140	173 061 016	10	0.217	9	17	98	98	110	10	10	32	M8
160	173 061 017	10	0.237	9	17	109	109	108	10	10	32	M8

KLIP-IT Spacer Type 061, PE

Model:

- For pipe clips Type 061, PE black, UV resistant
- **Minimum order quantity: standard packaging SP**

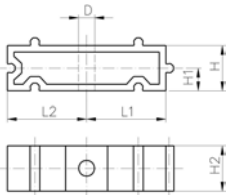

d [mm]	Inch	Code	SP	kg	D [mm]	L1 [mm]	L2 [mm]	H [mm]	H1 [mm]	H2 [mm]	SC
	1/8-1/4	173 061 153	10	0.003	5	11	14	20	10	12	M4
16	3/8	173 061 155	10	0.005	6	14	17	20	10	16	M5
20	1/2	173 061 156	10	0.006	6	17	19	20	10	16	M5
25	3/4	173 061 157	10	0.007	6	19	22	20	10	16	M5
32	1	173 061 158	10	0.008	6	24	27	20	10	16	M5
40	1 1/4	173 061 159	10	0.016	7	34	34	20	10	22	M6
50	1 1/2	173 061 160	10	0.017	7	37	37	20	10	22	M6
63	2	173 061 161	10	0.025	9	45	45	20	10	25	M8
75	2 1/2	173 061 162	10	0.027	9	52	52	20	10	25	M8
90	3	173 061 163	10	0.040	9	65	65	20	10	28	M8
110	4	173 061 164	10	0.048	9	79	79	20	10	28	M8
125	4 1/2	173 061 165	10	0.059	9	88	88	20	10	32	M8
140	5	173 061 166	10	0.065	9	98	98	20	10	32	M8
160	6	173 061 167	10	0.074	9	109	109	20	10	32	M8



Pipe Clips Type 060, PP metric





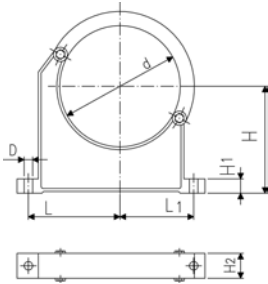

Model:

- For mm pipes d90-400
- Material: Clip and safety clip PP black, UV resistant
- Accidental opening of the safety clip is not possible
- **Minimum order quantity: standard packaging SP or gross packaging GP**
- Clip and safety clip are not assembled in the packaging.
- Pipes with flanges can be installed directly



d [mm]	d [inch]	Code	SP	kg	D [mm]	L [mm]	L1 [mm]	H [mm]	H1 [mm]	H2 [mm]	SC	
90	3	167 060 038	10	0.163	9	89	71	105	15	33	M 8	
110		167 060 039	10	0.179	9	94	80	115	15	33	M 8	
125		167 060 040	10	0.300	11	116	91	130	20	35	M10	
140	5	167 060 041	10	0.309	11	121	98	130	20	35	M10	
160		167 060 042	10	0.348	11	131	107	148	20	35	M10	
180		167 060 043	10	0.378	11	143	115	163	20	35	M10	
200		167 060 019	5	0.582	13	152	120	175	25	39	M12	
225		167 060 020	5	0.612	13	165	132	175	25	39	M12	
250		167 060 021	5	0.698	13	183	143	200	25	39	M12	
280		167 060 022	5	0.722	13	198	156	200	25	39	M12	
315		167 060 023	5	0.842	13	219	172	225	25	39	M12	
355		167 060 024	5	1.250	17	275	209	258	30	50	M16	
400		167 060 025	5	1.450	17	300	228	288	30	50	M16	

System Orientated Fusion Machines

		Page
	IR-63 Plus® Fusion Jointing Machine and Accessories	160
	IR-225 Plus® Fusion Jointing Machine and Accessories	161
	IR-315 Plus® Fusion Jointing Machine	162
	Accessories for the IR plastic fusion jointing machines	163
	BCF® Plus Plastic Fusion Jointing Machine	164
	SG 160 Combined butt and socket fusion machine	173
	Tools	174

IR-63 Plus® Fusion Jointing Machine and Accessories



IR-63 Plus® Fully-Equipped Machine

Fully-equipped fusion jointing machine for welding SYGEF® Standard, SYGEF® Plus, DEKAPROP®, PROGEF® Natural, PROGEF® Plus, PE 100 in dimensions d 20-63 mm with integrated remote welding unit.

Supply:

1-phase AC (50/60 Hz) 230 V L/N/PE

Delivery includes:

- Machine housing complete (1 pcs.)
- Heater assembly (1 pcs.)
- Remote weld device (1 pcs.)
- Facing tool (1 pcs.)
- Transport box (1 pcs.)
- Pipe stop (1 pcs.)
- Clamping inserts d 20-63 mm (8 pcs. per dimension)
- End caps PE d 20-63 mm (4 pcs. per dimension)
- Power supply cable 230 V (1 pcs.)
- Extension cable for remote weld device (1 pcs.)
- Extension cable for heater (1 pcs.)
- Extension cable for facing tool (1 pcs.)
- Cleaning brush No. 8 (1 pcs.)
- Hexagon key 3 mm (1 pcs.)
- Hexagon key 4 mm (1 pcs.)
- Heater protection shield (1 pcs.)
- Clamping unit extension (8 pcs.)
- Socket wrench (facing blades) (1 pcs.)
- Screw driver, Size 0 (1 pcs.)
- HP-Accessory Tray (1 pcs.)
- Manual (1 pcs.)

d-d [mm]	Code	kg	
20 - 63	790 131 005	52.000	

IR-225 Plus[®] Fusion Jointing Machine and Accessories



IR-225 Plus[®] Fully-Equipped Machine with HP Working Table (HP = High Purity)

Fully-equipped fusion jointing machine for welding SYGEF[®] Standard, SYGEF[®] Plus, DEKAPROP[®], PROGEF[®] Natural, PROGEF[®] Plus, PE 100 in dimensions d 63-225 mm.

Supply:

1-phase AC (50/60 Hz) 230 V L/N/PE or 3-phase AC (50/60 Hz) 400 V/230 V L1/L2/L3/N/PE

Delivery includes:

- Machine base (1 pcs.)
- Heater assembly (1 pcs.)
- Facing tool (1 pcs.)
- Working table, HP (1 pcs.)
- Movable clamping units (1 pcs.)
- Clamping inserts d 63-225 mm (8 pcs. per dimension)
- End caps PE d 63-225 mm (4 pcs. per dimension)
- Transportation lock (1 pcs.)
- Pipe stop (1 pcs.)
- Hexagon key 5 mm (1 pcs.)
- Hexagon key 6 mm (1 pcs.)
- Combination ring /open-jaw wrench 13 mm (1 pcs.)
- Cleaning brush (1 pcs.)
- Connecting cable 400 V - 230 V (1 pcs.)
- Ball for lever (1 pcs.)
- Manual (1 pcs.)

d-d [mm]	Code	kg	
63 - 225	790 133 009	453.000	

IR-315 Plus[®] Fusion Jointing Machine

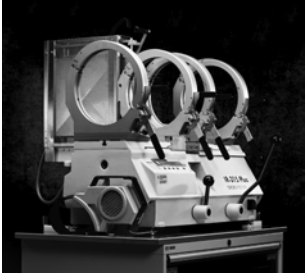

IR-315 Plus[®] Fully-Equipped Machine with HP Working Table (HP = High Purity)

Model:

- Fully-equipped fusion jointing machine for welding SYGEF[®] Standard, SYGEF[®] Plus in dimensions d 250-315.
- **Only a rental pool machine**

d-d [mm]		Code	
250 - 315	On request	-	

Accessories for the IR plastic fusion jointing machines



IR Plus® Win Weld

- The PC data transfer software makes it possible to manage and evaluate easily the recorded fusion data as required.
- **incl. Recordcard**

	Code	kg	Pieces
WIN 2000/XP	790 131 471	0.151	1
WIN 95/98/Me	790 131 472	0.220	1



IR Plus® Recordcard

- Fusion data from the machine can be stored on an exchangeable protocol card (record card) with a storage capacity of approx. 900 fusion protocols. It allows a paperless documentation.

Code	kg	Pieces
790 131 473	0.065	1

BCF[®] Plus Plastic Fusion Jointing Machine



BCF[®] Plus fully equipped machine d 20 - 63 mm

Fully-equipped machine for bead and crevice free jointing of SYGEF[®] Standard, SYGEF[®] Plus, PROGEF[®] Natural of the dimensions d 20-63 mm with integrated remote welding unit.

Supply:

1-phase AC (50/60 Hz) 115 / 230 V L/N/PE

Delivery includes:

- Machine housing (1 pcs.) incl. remote welding unit (1 pcs.)
- Transport box (1 pcs.)
- HP working table (1 pcs.)
- Heating stations d 20-63 mm (6 pcs.)
- Clamping units small (2 pcs.) with clamping inserts d 20-63 mm (24 pcs.)
- Facing tool small (1 pcs.) with facing inserts d 20-63 mm (6 pcs.)
- Facing tool support (1 pcs.)
- Hose box (1 pcs.) incl. air hose (1 pcs.)
- Supporting tools small d 20-63 mm (2 pcs.)
- BReT (1 pcs.)
- Hose cutter (1 pcs.)
- Air hose reducer (6-4 mm) (1 pcs.), air hose socket (4-4 mm) (1 pcs.)
- Extension cable (1 pcs.)
- Manual (1 pcs.)

d-d [mm]	Code	kg	
20 - 63	790 121 002	153.000	



BCF[®] Plus fully-equipped machine d 20 -110 mm

Fully-equipped machine for bead and crevice free jointing of SYGEF[®] Standard, SYGEF[®] Plus, PROGEF[®] Natural of the dimensions d 20-110 mm with integrated remote welding unit.

Supply:

1-phase AC (50/60 Hz) 115 / 230 V L/N/PE

Delivery includes:

- Machine housing (1 pcs.) incl. remote welding unit (1 pcs.)
- Transport box (1 pcs.)
- HP working table (1 pcs.)
- Heating stations d 20-110 mm (9 pcs.)
- Clamping units small (2 pcs.) with clamping inserts d 20-63 mm (24 pcs.)
- Clamping units big (2 pcs.) with clamping inserts d 75-110 mm (12 pcs.)
- Adapter for clamping unit d 75-110 mm (2 pcs.)
- Facing tool small (1 pcs.) with facing inserts d 20-63 mm (6 pcs.)
- Facing tool big (1 pcs.) with facing inserts d 75-110 mm (3 pcs.)
- Facing tool support (1 pcs.)
- Hose box (1 pcs.) incl. air hose (1 pcs.)
- Supporting tools small d 20-63 mm (2 pcs.)
- Supporting tools big d 75-110 mm (2 pcs.)
- BReT (1 pcs.)
- Hose cutter (1 pcs.)
- Air hose reducer (6-4 mm) (1 pcs.), air hose socket (4-4 mm) (1 pcs.)
- Extension cable (1 pcs.)
- Manual (1 pcs.)

d-d [mm]	Code	kg	
20 - 110	790 121 001	188.000	



BCF[®] Plus basic machine d 20-63 mm

Fully-equipped machine for bead and crevice free jointing of SYGEF[®] Standard, SYGEF[®] Plus, PROGEF[®] Natural of the dimensions d 20-63 mm with integrated remote welding unit

Supply:

1-phase AC (50/60 Hz) 115 / 230 V L/N/PE

Scope of delivery includes:

- Machine housing (1 pcs.) with remote welding unit (1 pcs.)
- Transport box (1 pcs.)
- HP working table (1 pcs.)
- Clamping units small (2 pcs.) with clamping inserts d 20-63 mm (24 pcs.)
- Facing tool small (1 pcs.) with facing inserts d 20-63 mm (6 pcs.)
- Facing tool support (1 pcs.)
- Hose box (1 pcs.) incl. air hose (1 pcs.)
- Supporting tools small (2 pcs.)
- BReT (1 pcs.)
- Hose cutter (1 pcs.)
- Inbus T-screwdriver (1 pcs.)
- Air hose reducer (6-4 mm) (1 pcs.)
- Air hose socket (4-4 mm) (1 pcs.)
- Extension cable (1 pcs.)
- Power supply cable (1 pcs.)
- Manual (1 pcs.)

d-d [mm]	Code	kg	
20 - 63	790 121 004	144.000	



BCF[®] Plus basic machine d 75-110 mm

Fully-equipped machine for bead and crevice free jointing of SYGEF[®] Standard, SYGEF[®] Plus, PROGEF[®] Natural of the dimensions d 75-110 mm with integrated remote welding unit

Supply:

1-phase AC (50/60 Hz) 115 / 230 V L/N/PE

Delivery includes:

- Machine housing (1 pcs.) with remote welding unit (1 pcs.)
- Transport box (1 pcs.)
- HP working table (1 pcs.)
- Clamping units big (2 pcs.) with clamping inserts d 75-110 mm (12 pcs.)
- Adapter for clamping unit d 75-110 mm (2 pcs.)
- Facing tool big (1 pcs.) with facing inserts d 75-110 mm (3 pcs.)
- Facing tool support (1 pcs.)
- Hose box (1 pcs.) incl. air hose (1 pcs.)
- Supporting tools big (2 pcs.)
- BReT (1 pcs.)
- Hose cutter (1 pcs.)
- Inbus T-screwdriver (1 pcs.)
- Air hose reducer (6-4 mm) (1 pcs.)
- Air hose socket (4-4 mm) (1 pcs.)
- Extension cable (1 pcs.)
- Power supply cable (1 pcs.)
- Manual (1 pcs.)

d-d [mm]	Code	kg	
75 - 110	790 121 005	155.000	



BCF[®] Plus basic machine d 20 -110 mm

Fully-equipped machine for bead and crevice free jointing of SYGEF[®] Standard, SYGEF[®] Plus, PROGEF[®] Natural of the dimensions d 20-110 mm with integrated remote welding unit

Supply:

1-phase AC (50/60 Hz) 115/ 230 V L/N/PE

Delivery includes:

- Machine housing (1 pcs.) with remote welding unit (1 pcs.)
- Transport box (1 pcs.)
- HP working table (1 pcs.)
- Clamping units small (2 pcs.) with clamping inserts d 20-63 mm (24 pcs.)
- Clamping units big (2 pcs.) with clamping inserts d 75-110 mm (12 pcs.)
- Adapter for clamping unit d 75-110 mm (2 pcs.)
- Facing tool small (1 pcs.) with facing inserts d 20-63 mm (6 pcs.)
- Facing tool big (1 pcs.) with facing inserts d 75-110 mm (3 pcs.)
- Facing tool support (1 pcs.)
- Hose box (1 pcs.) incl. air hose (1 pcs.)
- Supporting tools small d 20-63 mm (2 pcs.)
- Supporting tools big d 75-110 mm (2 pcs.)
- BReT (1 pcs.)
- Hose cutter (1 pcs.)
- Inbus T-screwdriver (1 pcs.)
- Air hose reducer (6-4 mm) (1 pcs.)
- Air hose socket (4-4 mm) (1 pcs.)
- Extension cable (1 pcs.)
- Power supply cable (1 pcs.)
- Manual (1 pcs.)

d-d [mm]	Code	kg	
20 - 110	790 121 006	161.000	

BCF[®] Plus dimension packet d 20-63 mm

- This package is necessary to complete BCF[®] Plus machines which are only equipped for large dimensions d 75-110 mm.
- **Delivery includes:**
- Clamping units small (2 pcs.) with clamping inserts d 20-63 mm (24 pcs.)
- Facing tool small (1 pcs.) with facing inserts d 20-63 mm (6 pcs.)
- Supporting tools small (2 pcs.)

d-d [mm]	Code	kg	
20 - 63	790 121 023	6.225	

BCF[®] Plus dimension packet d 75-110 mm

- This package is necessary to complete BCF[®] Plus machines which are only equipped for small dimensions d 20-63 mm.
- **Delivery includes:**
- Clamping units big (2 pcs.) with clamping inserts d 75-110 mm (12 pcs.)
- Facing tool big (1 pcs.) with facing inserts d 75-110 mm (3 pcs.)
- Supporting tools tall (2 pcs.)
- Adapter for clamping unit d 75-110 mm (2 pcs.)

d-d [mm]	Code	kg	
75 - 110	790 121 022	8.000	



BCF[®] Plus Heating stations

d [mm]	Code	kg	Pieces	
20	790 121 111	1.800	1	
25	790 121 112	1.820	1	
32	790 121 113	1.890	1	
40	790 121 114	2.400	1	
50	790 121 115	2.400	1	
63	790 121 116	2.150	1	
75	790 121 117	3.600	1	
90	790 121 118	3.600	1	
110	790 121 119	3.520	1	



BCF[®] Bladder for SYGEF[®] PVDF

- Only suitable for welding SYGEF[®] PVDF and not for PROGEF[®] Natural. **Silver bladder head!**

d [mm]	Code	kg	Pieces	
20	790 122 041	0.014	1	
25	790 122 042	0.029	1	
32	790 122 043	0.037	1	
40	790 122 044	0.055	1	
50	790 122 045	0.108	1	
63	790 122 046	0.152	1	
75	790 121 047	0.152	1	
90	790 121 048	0.204	1	
110	790 121 049	0.428	1	



BCF[®] Plus Bladder

- Only suitable for welding PROGEF[®] Natural). **Blue bladder head** (except d 75 -110mm)!

d [mm]	Code	kg	Pieces
20	790 122 091	0.038	1
25	790 122 092	0.044	1
32	790 122 093	0.062	1
40	790 122 094	0.082	1
50	790 122 095	0.131	1
63	790 122 096	0.168	1



BCF[®] Plus facing tool

- Inclusive crank handle, mounting material and clamping inserts. Suitable for SYGEF[®] PVDF as well as PROGEF[®] Natural.

d-d [mm]	Code	kg	Pieces
20 - 63	790 121 052	1.400	1
75 - 110	790 121 053	3.000	1



BCF[®] Plus clamping inserts for the facing tool

- These dimension-specific parts are inserted into the facing tool, in order to be able to face the end of the pipes smoothly and parallel.

d [mm]	Code	kg	Pieces
20	790 121 061	0.160	1
25	790 121 062	0.150	1
32	790 121 063	0.132	1
40	790 121 064	0.125	1
50	790 121 065	0.100	1
63	790 121 066	0.050	1
75	790 121 067	0.300	1
90	790 121 068	0.200	1
110	790 121 069	0.090	1



BCF[®] Plus facing tool mounting plate

- To fix the facing tool on the workbench.

d-d [mm]	Code	kg	Pieces
20 - 110	790 121 055	1.200	1



BCF[®] Plus clamping units

- The clamping units are adjustable, so that all types of pipes and fittings can be clamped.

d-d [mm]	Code	kg	Pieces
20 - 63	790 121 034	0.001	1
75 - 110	790 121 035	0.900	1



BCF[®] Plus adapter for clamping unit d 75-110 mm

- The adapter makes it possible, to insert clamping inserts with d 20-63 mm in clamping units with d 75-110 mm to be able to clamp pipes and fittings with d 20-63 mm with these clamping units.

d-d [mm]	Code	kg	Pieces
75 - 110	790 121 038	0.250	1



BCF[®] Plus clamping inserts

- The clamping inserts are suitable for the clamping units of the BCF[®]Plus machine. They are used to clamp the piping components.
- **No** clamping inserts are needed for **d 110 mm!**

d [mm]	Code	kg	Pieces
20	790 131 038	0.090	1
25	790 131 039	0.090	1
32	790 131 040	0.083	1
40	790 131 041	0.075	1
50	790 131 042	0.100	1
63	790 131 043	0.040	1
75	790 121 036	0.143	1
90	790 121 037	0.095	1



BCF[®] Plus hose box

- For the clean and professional storage of the air hose.

Code	kg	Pieces
790 121 077	0.001	1



BCF[®] Plus hose

- Connection hose for the BCF[®]Plus bladder.

Code	kg	Length [mm]
790 122 087	0.126	16



BCF[®] Plus supporting tool

- Helpful to fix 45°- angle components.

d-d [mm]	Code	kg	Pieces
20 - 63	790 121 072	0.542	1
75 - 110	790 121 073	0.900	1



BCF[®] Plus bladder/ hose remove tool (BReT)

- Helpful to remove bladders easily.

Code	kg	Pieces
790 121 075	0.079	1



BCF[®] Plus extension cable

- The extension cable enable the fusion e. g. under the ceiling.

Code	kg	Length [mm]	
790 121 010	2.000	8	

SG 160 Combined butt and socket fusion machine

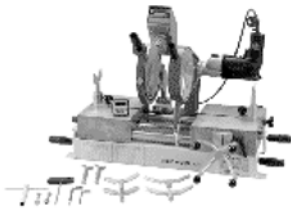

SG160

For fusion jointing PP, PE and PVDF pipes and fittings size range for butt fusion d 32 - 160

Note:

- Mobile, very compact and universal plastic fusion machine for use in the workshop and on job sites.

* Different version for other countries.

d-d [mm]	Performance	Code	kg	
16 - 160	230 V	790 103 031	45.000	
16 - 160	115 V	790 103 033	45.000	

Tools

Spare Cutting Wheel

- for plastic pipe cutter



d-d [mm]	Article	Code	kg
10 - 63	SR 63 max. s=7,2 mm	790 109 011	0.004
50 - 110	SR 110/160 max. s=12,7 mm	790 109 012	0.015
110 - 160	SR 160 max. s=19,0 mm	790 109 013	0.023



Chamfering Tool

Size	d-d [mm]	Code	kg
1	16 - 75	799 495 145	0.720
2	32 - 200	799 495 146	0.992

Cutter for Chamfering Tool

Size	d-d [mm]	Code	kg
1+2	16 - 250	708 402 217	0.010



Tempil Sticks for socket fusion

Fuse temperature [°C]	Code	kg
253	799 496 008	0.014
274	799 496 009	0.018



Cleaning Tissue<KO-TON-R>

- Minimum order quantity 50

Code	kg
790 122 085	0.004

Code Index

Code	Page
161 311 698	58
161 311 699	58
161 311 700	58
161 311 701	58
161 311 702	58
161 311 703	58
161 481 022	58
161 481 023	58
161 481 024	58
161 481 025	58
161 481 026	58
161 481 027	58
161 481 092	58
161 481 093	58
161 481 094	58
161 481 095	58
161 481 096	58
161 481 097	58
161 481 926	58
161 481 927	58
161 481 928	58
161 481 929	58
161 481 930	58
161 481 931	58
161 482 920	90
161 482 921	90
161 482 922	90
161 482 923	90
161 482 924	90
161 482 925	90
161 484 452	58
161 484 453	58
161 484 454	58
161 484 455	58
161 484 456	58
161 484 457	58
161 484 625	58
161 484 626	58
161 484 627	58
161 484 628	58
161 484 629	58
161 484 630	58
161 484 632	58
161 484 633	58
161 484 688	58
161 484 689	58
161 484 690	58
161 484 691	58
161 484 692	58
161 484 693	58
161 484 696	58
161 484 697	58
161 484 698	58
161 484 699	58
161 484 700	58
161 484 701	58
161 484 704	58
161 484 705	58
161 484 706	58
161 484 707	58
161 484 708	58
161 484 709	58
161 484 875	104
161 484 876	104
161 484 877	104
161 484 878	104
161 484 879	104

Code	Page
161 484 880	104
161 484 881	104
161 484 887	104
161 484 888	104
161 484 889	104
161 484 890	104
161 484 891	104
161 484 892	104
161 484 893	104
161 484 894	104
161 484 895	104
161 484 896	104
161 484 897	104
161 484 912	104
161 484 913	104
161 484 914	104
161 484 915	104
161 484 916	104
161 484 917	104
161 484 918	104
161 484 919	104
161 484 920	104
161 484 921	104
161 484 951	85
161 484 952	85
161 484 953	85
161 484 954	85
161 484 955	85
161 484 956	85
161 486 410	75
161 486 411	75
161 486 412	75
161 486 413	75
161 486 414	75
161 486 415	75
161 486 435	73
161 486 436	73
161 486 437	73
161 486 438	73
161 486 443	73
161 486 444	73
161 486 445	73
161 486 446	73
161 486 690	100
161 486 691	100
161 486 694	100
161 486 695	100
161 486 899	100
161 486 900	100
161 486 901	100
161 486 902	100
161 486 903	100
161 486 904	100
161 486 905	100
161 486 959	100
161 486 960	100
161 486 961	100
161 486 962	100
161 486 963	100
161 486 964	100
161 486 965	100
161 486 979	100
161 486 980	100
161 486 981	100
161 486 982	100
161 486 983	100
161 486 984	100

Code	Page
161 486 985	100
1614848893	104
1614848894	104
1614848895	104
1614849122	104
167 060 019	157
167 060 020	157
167 060 021	157
167 060 022	157
167 060 023	157
167 060 024	157
167 060 025	157
167 060 038	157
167 060 039	157
167 060 040	157
167 060 041	157
167 060 042	157
167 060 043	157
167 061 035	155
167 061 036	155
167 061 037	155
167 061 038	155
167 061 039	155
167 061 040	155
167 061 041	155
167 061 153	155
167 061 155	155
167 061 156	155
167 061 157	155
167 061 158	155
167 061 159	155
167 061 160	155
167 061 161	155
167 061 162	155
167 061 163	155
167 061 164	155
167 061 165	155
167 061 166	155
167 061 167	155
167 482 626	70
167 482 627	70
167 482 628	70
167 482 629	70
167 482 635	70
167 482 636	70
167 482 637	70
167 482 638	70
167 482 653	72
167 482 654	72
167 482 655	72
167 482 656	72
167 482 662	71
167 482 663	71
167 482 664	71
167 482 665	71
167 482 671	71
167 482 672	71
167 482 673	71
167 482 674	71
167 482 680	69
167 482 681	69
167 482 682	69
167 482 683	69
167 483 252	100
167 483 253	100
167 484 076	75
167 484 077	75

Code Index

Code	Page
167 484 078	75
167 484 079	75
167 484 080	75
167 484 081	75
167 484 088	75
167 484 089	75
167 484 090	75
167 484 091	75
167 484 092	75
167 484 093	75
167 484 100	75
167 484 101	75
167 484 102	75
167 484 103	75
167 484 104	75
167 484 105	75
167 484 110	72
167 484 111	72
167 486 251	100
173 061 003	156
173 061 004	156
173 061 005	156
173 061 006	156
173 061 007	156
173 061 008	156
173 061 009	156
173 061 010	156
173 061 011	156
173 061 012	156
173 061 013	156
173 061 014	156
173 061 015	156
173 061 016	156
173 061 017	156
173 061 153	156
173 061 155	156
173 061 156	156
173 061 157	156
173 061 158	156
173 061 159	156
173 061 160	156
173 061 161	156
173 061 162	156
173 061 163	156
173 061 164	156
173 061 165	156
173 061 166	156
173 061 167	156
175 314 362	123
175 314 363	123
175 314 364	123
175 314 365	123
175 314 366	123
175 314 367	123
175 314 432	53
175 314 433	53
175 314 434	53
175 314 435	53
175 314 436	53
175 314 437	53
175 314 532	54
175 314 533	54
175 314 534	54
175 314 535	54
175 314 536	54
175 314 537	54
175 314 662	124

Code	Page
175 314 663	124
175 314 664	124
175 314 665	124
175 314 666	124
175 314 667	124
175 315 368	125
175 315 432	55
175 315 433	55
175 315 434	55
175 315 435	55
175 315 436	55
175 315 437	55
175 315 532	55
175 315 533	55
175 315 534	55
175 315 535	55
175 315 536	55
175 315 537	55
175 315 562	125
175 315 563	125
175 315 564	125
175 315 565	125
175 315 566	125
175 315 567	125
175 315 602	126
175 315 603	126
175 315 604	126
175 315 605	126
175 315 606	126
175 315 607	126
175 317 009	56
175 317 010	56
175 317 012	56
175 317 054	127
175 317 055	127
175 317 057	127
175 317 339	57
175 317 340	57
175 317 355	128
175 317 432	56
175 317 433	56
175 317 434	56
175 317 435	56
175 317 436	56
175 317 437	56
175 317 438	56
175 317 447	127
175 317 448	127
175 317 449	127
175 317 450	127
175 317 451	127
175 317 452	127
175 317 453	127
175 317 532	57
175 317 533	57
175 317 534	57
175 317 535	57
175 317 536	57
175 317 537	57
175 317 538	57
175 317 562	128
175 317 563	128
175 317 564	128
175 317 565	128
175 317 566	128
175 317 567	128
175 317 568	128

Code	Page
175 319 301	129
175 319 303	129
175 319 304	129
175 319 307	129
175 319 308	129
175 319 309	129
175 319 312	129
175 319 313	129
175 319 314	129
175 319 315	129
175 319 318	129
175 319 319	129
175 319 320	129
175 319 321	129
175 319 322	129
175 319 325	129
175 319 326	129
175 319 327	129
175 319 328	129
175 319 329	129
175 319 330	129
175 319 336	129
175 319 337	129
175 319 338	129
175 319 341	129
175 319 342	129
175 319 343	129
175 319 345	129
175 319 346	129
175 319 351	129
175 319 352	129
175 319 353	129
175 319 355	129
175 319 356	129
175 319 601	131
175 319 603	131
175 319 604	131
175 319 607	131
175 319 608	131
175 319 609	131
175 319 612	131
175 319 613	131
175 319 614	131
175 319 615	131
175 319 618	131
175 319 619	131
175 319 620	131
175 319 621	131
175 319 622	131
175 319 625	131
175 319 626	131
175 319 627	131
175 319 628	131
175 319 629	131
175 319 630	131
175 319 636	131
175 319 637	131
175 319 638	131
175 319 641	131
175 319 642	131
175 319 643	131
175 319 645	131
175 319 646	131
175 319 651	131
175 319 652	131
175 319 653	131
175 319 655	131

Code Index

Code	Page
175 319 656	131
175 343 011	76
175 343 012	76
175 343 013	76
175 343 014	76
175 343 015	76
175 343 016	76
175 343 017	76
175 343 031	77
175 343 032	77
175 343 033	77
175 343 034	77
175 343 035	77
175 343 036	77
175 343 037	77
175 343 051	78
175 343 052	78
175 343 053	78
175 343 054	78
175 343 055	78
175 343 056	78
175 343 057	78
175 343 071	79
175 343 072	79
175 343 073	79
175 343 074	79
175 343 075	79
175 343 076	79
175 343 077	79
175 343 111	80
175 343 112	80
175 343 113	80
175 343 114	80
175 343 115	80
175 343 116	80
175 343 117	80
175 343 131	81
175 343 132	81
175 343 133	81
175 343 134	81
175 343 135	81
175 343 136	81
175 343 137	81
175 343 151	82
175 343 152	82
175 343 153	82
175 343 154	82
175 343 155	82
175 343 156	82
175 343 157	82
175 343 171	83
175 343 172	83
175 343 173	83
175 343 174	83
175 343 175	83
175 343 176	83
175 343 177	83
175 360 411	86
175 360 412	86
175 360 413	86
175 360 414	86
175 360 415	86
175 360 416	86
175 360 417	86
175 360 451	86
175 360 452	86
175 360 453	86

Code	Page
175 360 454	86
175 360 455	86
175 360 456	86
175 360 457	86
175 360 492	87
175 360 493	87
175 360 494	87
175 360 495	87
175 360 496	87
175 360 497	87
175 360 611	88
175 360 612	88
175 360 613	88
175 360 614	88
175 360 615	88
175 360 616	88
175 360 617	88
175 360 631	89
175 360 632	89
175 360 633	89
175 360 634	89
175 360 635	89
175 360 636	89
175 360 637	89
175 360 671	88
175 360 672	88
175 360 673	88
175 360 674	88
175 360 675	88
175 360 676	88
175 360 677	88
175 369 022	101
175 369 023	101
175 369 024	101
175 369 025	101
175 369 026	101
175 369 027	101
175 369 029	101
175 369 030	101
175 369 031	101
175 369 032	101
175 369 033	101
175 369 062	102
175 369 063	102
175 369 064	102
175 369 065	102
175 369 066	102
175 369 067	102
175 369 069	102
175 369 070	102
175 369 071	102
175 369 072	102
175 369 073	102
175 369 102	103
175 369 103	103
175 369 104	103
175 369 105	103
175 369 106	103
175 369 107	103
175 369 109	103
175 369 110	103
175 369 111	103
175 369 112	103
175 369 113	103
175 480 031	85
175 480 032	85
175 480 033	85

Code	Page
175 480 034	85
175 480 035	85
175 480 036	85
175 480 037	85
175 480 153	90
175 480 154	90
175 480 155	90
175 480 156	90
175 480 157	90
175 480 158	90
175 480 202	31
175 480 203	31
175 480 204	31
175 480 205	31
175 480 206	31
175 480 207	31
175 480 208	31
175 480 209	31
175 480 210	31
175 480 211	31
175 480 213	31
175 480 214	31
175 480 216	31
175 480 217	31
175 480 319	140
175 480 656	31
175 480 665	31
175 480 666	31
175 480 667	31
175 480 668	31
175 480 669	31
175 480 670	31
175 480 671	31
175 480 673	31
175 480 674	31
175 480 727	85
175 480 728	85
175 480 729	85
175 480 730	85
175 480 731	85
175 480 732	85
175 480 733	85
175 480 787	85
175 480 788	85
175 480 789	85
175 480 790	85
175 480 791	85
175 480 792	85
175 480 793	85
175 480 796	85
175 480 797	85
175 480 798	85
175 480 799	85
175 480 800	85
175 480 801	85
175 480 802	85
175 480 819	85
175 480 820	85
175 480 821	85
175 480 822	85
175 480 823	85
175 480 824	85
175 481 202	106
175 481 203	106
175 481 204	106
175 481 205	106
175 481 206	106

Code Index

Code	Page
175 481 207	106
175 481 208	106
175 481 209	106
175 481 210	106
175 481 211	106
175 481 212	106
175 481 213	106
175 481 214	106
175 481 216	106
175 481 217	106
175 481 656	106
175 481 665	106
175 481 666	106
175 481 667	106
175 481 668	106
175 481 669	106
175 481 670	106
175 481 671	106
175 481 673	106
175 481 674	106
175 481 860	58
175 481 861	58
175 481 862	58
175 481 863	58
175 481 977	58
175 481 978	58
175 481 979	58
175 481 980	58
175 481 981	58
175 481 982	58
175 482 593	85
175 482 594	85
175 482 595	85
175 482 596	85
175 482 597	85
175 482 598	85
175 482 620	85
175 482 621	85
175 482 622	85
175 482 623	85
175 482 624	85
175 482 625	85
175 482 662	85
175 482 663	85
175 482 664	85
175 482 665	85
175 482 666	85
175 482 667	85
175 482 687	85
175 482 688	85
175 482 689	85
175 482 690	85
175 482 691	85
175 482 937	75
175 482 938	75
175 482 939	75
175 482 940	75
175 482 941	75
175 482 942	75
175 482 963	75
175 482 964	75
175 482 965	75
175 482 966	75
175 482 967	75
175 482 968	75
175 483 025	75
175 483 026	75

Code	Page
175 483 027	75
175 483 028	75
175 483 029	75
175 483 030	75
175 483 031	75
175 483 036	75
175 483 037	75
175 483 038	75
175 483 039	75
175 483 040	75
175 483 041	75
175 483 042	75
175 483 048	75
175 483 049	75
175 483 050	75
175 483 051	75
175 483 052	75
175 483 053	75
175 483 058	75
175 483 059	75
175 483 060	75
175 483 061	75
175 483 062	75
175 483 063	75
175 483 064	75
175 483 251	100
175 483 252	100
175 483 253	100
175 483 254	100
175 483 255	100
175 483 256	100
175 483 257	100
175 483 275	75
175 483 276	75
175 483 277	75
175 483 278	75
175 483 279	75
175 483 280	75
175 483 285	75
175 483 286	75
175 483 287	75
175 483 288	75
175 483 289	75
175 483 290	75
175 483 413	100
175 483 414	100
175 483 415	100
175 483 416	100
175 483 417	100
175 483 418	100
175 483 419	100
175 483 426	100
175 483 427	100
175 483 428	100
175 483 459	134
175 483 461	134
175 483 464	134
175 483 466	134
175 483 468	134
175 483 470	134
175 483 472	134
175 546 011	64
175 546 012	64
175 546 013	64
175 546 014	64
175 546 015	64
175 546 016	64

Code	Page
175 546 017	64
175 546 051	60
175 546 052	60
175 546 053	60
175 546 054	60
175 546 055	60
175 546 056	60
175 546 057	60
175 546 092	65
175 546 093	65
175 546 094	65
175 546 095	65
175 546 096	65
175 546 097	65
175 546 192	62
175 546 193	62
175 546 194	62
175 546 195	62
175 546 196	62
175 546 197	62
175 546 272	61
175 546 273	61
175 546 274	61
175 546 275	61
175 546 276	61
175 546 277	61
175 546 331	63
175 546 332	63
175 546 333	63
175 546 334	63
175 546 335	63
175 546 336	63
175 546 337	63
175 546 411	59
175 546 412	59
175 546 413	59
175 546 414	59
175 546 415	59
175 546 416	59
175 546 417	59
175 546 431	66
175 546 432	66
175 546 433	66
175 546 434	66
175 546 435	66
175 546 436	66
175 546 437	66
175 546 691	67
175 546 692	67
175 546 693	67
175 546 694	67
175 546 695	67
175 546 696	67
175 546 697	67
175 546 752	68
175 546 753	68
175 546 754	68
175 546 755	68
175 546 756	68
175 546 757	68
175 567 002	91
175 567 003	91
175 567 004	91
175 567 005	91
175 567 006	91
175 567 007	91
175 567 008	91

Code Index

Code	Page
175 567 022	92
175 567 023	92
175 567 024	92
175 567 025	92
175 567 026	92
175 567 027	92
175 567 028	92
175 567 822	93
175 567 823	93
175 567 824	93
175 567 825	93
175 567 826	93
175 567 827	93
175 567 828	93
175 568 002	94
175 568 003	94
175 568 004	94
175 568 005	94
175 568 006	94
175 568 007	94
175 568 008	94
175 568 022	95
175 568 023	95
175 568 024	95
175 568 025	95
175 568 026	95
175 568 027	95
175 568 028	95
175 568 102	97
175 568 103	97
175 568 104	97
175 568 105	97
175 568 106	97
175 568 107	97
175 568 108	97
175 568 122	98
175 568 123	98
175 568 124	98
175 568 125	98
175 568 126	98
175 568 127	98
175 568 128	98
175 568 822	96
175 568 823	96
175 568 824	96
175 568 825	96
175 568 826	96
175 568 827	96
175 568 828	96
175 568 922	99
175 568 923	99
175 568 924	99
175 568 925	99
175 568 926	99
175 568 927	99
175 568 928	99
1754826892	85
708 402 217	174
724 700 319	149
724 700 320	149
724 700 321	149
724 700 322	149
724 700 323	149
724 700 324	149
724 700 325	149
724 700 424	149
724 700 425	149

Code	Page
724 700 426	149
724 700 427	149
724 700 428	149
724 700 429	149
727 700 021	148
727 700 206	147
727 700 207	147
727 700 208	147
727 700 209	147
727 700 210	147
727 700 211	147
727 700 212	147
727 700 213	148
727 700 214	148
727 700 215	148
727 700 216	148
727 700 217	148
727 700 219	148
727 700 220	148
727 700 221	148
727 700 222	148
727 700 223	148
727 700 224	148
727 700 225	148
727 700 313	147
727 700 314	147
727 700 315	147
727 700 316	147
727 700 317	147
727 700 318	147
727 700 319	147
727 700 320	147
727 700 321	147
727 700 322	147
727 700 323	147
727 700 324	147
727 700 325	147
727 700 406	144
727 700 407	144
727 700 408	144
727 700 409	144
727 700 410	144
727 700 411	144
727 700 412	144
727 700 413	145
727 700 414	145
727 700 416	145
727 700 417	145
727 700 419	145
727 700 420	145
727 700 421	145
727 700 422	145
727 700 423	145
727 700 513	144
727 700 514	144
727 700 515	144
727 700 516	144
727 700 517	144
727 700 518	144
727 700 519	144
727 700 520	144
727 700 521	144
727 700 522	144
727 700 523	144
727 701 206	149
727 701 207	149
727 701 208	149

Code	Page
727 701 209	149
727 701 210	149
727 701 211	149
727 701 212	149
727 701 213	149
727 701 214	149
727 701 217	149
727 701 220	149
727 701 406	146
727 701 407	146
727 701 408	146
727 701 409	146
727 701 410	146
727 701 411	146
727 701 412	146
727 701 413	146
727 701 414	146
727 701 422	146
727 701 423	146
727 701 513	146
727 701 514	146
727 701 521	146
727 701 522	146
727 701 523	146
735 018 513	32
735 018 514	32
735 018 515	32
735 018 516	32
735 018 517	32
735 018 519	32
735 018 520	32
735 018 538	107
735 018 539	107
735 018 540	107
735 018 541	107
735 018 542	107
735 018 544	107
735 018 545	107
735 018 546	107
735 018 547	107
735 018 548	107
735 018 706	32
735 018 707	32
735 018 708	32
735 018 709	32
735 018 710	32
735 018 711	32
735 018 712	32
735 018 713	32
735 018 714	32
735 018 716	32
735 018 717	32
735 018 719	32
735 018 720	32
735 018 731	107
735 018 732	107
735 018 733	107
735 018 734	107
735 018 735	107
735 018 736	107
735 018 737	107
735 018 738	107
735 018 739	107
735 018 741	107
735 018 742	107
735 018 744	107
735 018 745	107

Code Index

Code	Page
735 100 105	42
735 100 106	42
735 100 107	42
735 100 108	42
735 100 109	42
735 100 110	42
735 100 111	42
735 108 606	32
735 108 607	32
735 108 608	32
735 108 609	32
735 108 610	32
735 108 611	32
735 108 631	108
735 108 632	108
735 108 633	108
735 108 634	108
735 108 635	108
735 108 636	108
735 150 105	42
735 150 106	42
735 150 107	42
735 150 108	42
735 150 109	42
735 150 110	42
735 150 111	42
735 158 513	33
735 158 514	33
735 158 515	33
735 158 516	33
735 158 517	33
735 158 519	33
735 158 520	33
735 158 538	108
735 158 539	108
735 158 540	108
735 158 541	108
735 158 542	108
735 158 544	108
735 158 545	108
735 158 606	33
735 158 607	33
735 158 608	33
735 158 609	33
735 158 610	33
735 158 611	33
735 158 612	33
735 158 613	33
735 158 614	33
735 158 616	33
735 158 617	33
735 158 619	33
735 158 620	33
735 158 631	108
735 158 632	108
735 158 633	108
735 158 634	108
735 158 635	108
735 158 636	108
735 158 637	108
735 158 638	108
735 158 639	108
735 158 641	108
735 158 642	108
735 158 644	108
735 158 645	108
735 200 105	43

Code	Page
735 200 106	43
735 200 107	43
735 200 108	43
735 200 109	43
735 200 110	43
735 200 111	43
735 208 513	34
735 208 514	34
735 208 515	34
735 208 516	34
735 208 517	34
735 208 519	34
735 208 520	34
735 208 538	109
735 208 539	109
735 208 540	109
735 208 541	109
735 208 542	109
735 208 544	109
735 208 545	109
735 208 546	109
735 208 547	109
735 208 548	109
735 208 561	35
735 208 562	35
735 208 569	35
735 208 570	35
735 208 586	110
735 208 587	110
735 208 594	110
735 208 595	110
735 208 606	34
735 208 607	34
735 208 608	34
735 208 609	34
735 208 610	34
735 208 611	34
735 208 612	34
735 208 613	34
735 208 614	34
735 208 616	34
735 208 617	34
735 208 619	34
735 208 620	34
735 208 631	109
735 208 632	109
735 208 633	109
735 208 634	109
735 208 635	109
735 208 636	109
735 208 637	109
735 208 638	109
735 208 639	109
735 208 641	109
735 208 642	109
735 208 644	109
735 208 645	109
735 208 661	34
735 208 662	34
735 208 669	34
735 208 670	34
735 208 686	110
735 208 687	110
735 208 694	110
735 208 695	110
735 208 956	110
735 208 957	110

Code	Page
735 208 958	110
735 208 959	110
735 208 961	110
735 208 962	110
735 208 963	110
735 208 964	110
735 208 965	110
735 208 967	110
735 208 968	110
735 208 969	110
735 208 970	110
735 208 971	110
735 208 972	110
735 208 974	110
735 208 975	110
735 208 976	110
735 208 977	110
735 208 978	110
735 208 979	110
735 208 980	110
735 208 981	110
735 510 105	48
735 510 106	48
735 510 107	48
735 510 108	48
735 510 109	48
735 510 110	48
735 510 111	48
735 518 706	117
735 518 707	117
735 518 708	117
735 518 709	117
735 518 710	117
735 518 711	117
735 528 606	38
735 528 607	38
735 528 608	38
735 528 609	38
735 528 610	38
735 528 611	38
735 528 612	38
735 528 613	38
735 528 614	38
735 528 637	117
735 528 638	117
735 528 639	117
735 550 012	141
735 550 014	141
735 550 017	141
735 550 019	141
735 550 021	141
735 550 112	135
735 550 114	135
735 550 117	135
735 550 119	135
735 550 121	135
735 550 123	135
735 550 125	135
735 550 212	135
735 550 214	135
735 550 217	135
735 550 219	135
735 550 221	135
735 550 223	135
735 550 225	135
735 550 312	135
735 550 314	135

Code Index

Code	Page
735 550 317	135
735 550 319	135
735 550 321	135
735 550 323	135
735 550 325	135
735 550 412	136
735 550 414	136
735 550 417	136
735 550 419	136
735 550 421	136
735 550 423	136
735 550 425	136
735 550 512	136
735 550 514	136
735 550 517	136
735 550 519	136
735 550 521	136
735 550 523	136
735 550 525	136
735 550 612	138
735 550 614	138
735 550 617	138
735 550 619	138
735 550 621	138
735 550 623	138
735 550 625	138
735 550 712	138
735 550 714	138
735 550 717	138
735 550 719	138
735 550 721	138
735 550 723	138
735 550 725	138
735 550 814	136
735 550 817	136
735 550 819	136
735 550 821	136
735 550 823	136
735 550 825	136
735 550 912	141
735 550 914	141
735 550 917	141
735 550 919	141
735 550 921	141
735 598 006	120
735 598 008	120
735 598 009	120
735 598 010	120
735 598 014	120
735 598 016	120
735 598 018	120
735 598 056	120
735 598 057	120
735 598 059	120
735 598 062	120
735 598 065	120
735 598 067	120
735 598 157	120
735 598 159	120
735 598 163	120
735 598 165	120
735 598 167	120
735 598 169	120
735 598 207	121
735 598 209	121
735 598 213	121
735 598 215	121

Code	Page
735 598 217	121
735 598 219	121
735 598 259	121
735 598 262	121
735 598 265	121
735 598 267	121
735 598 269	121
735 598 309	121
735 598 312	121
735 598 315	121
735 598 317	121
735 598 319	121
735 598 357	122
735 598 359	122
735 598 362	122
735 598 365	122
735 598 367	122
735 598 369	122
735 598 406	122
735 598 408	122
735 598 410	122
735 598 414	122
735 598 416	122
735 598 418	122
735 598 506	122
735 598 508	122
735 598 510	122
735 600 105	49
735 600 106	49
735 600 107	49
735 600 108	49
735 600 109	49
735 600 110	49
735 600 111	49
735 608 606	38
735 608 607	38
735 608 608	38
735 608 609	38
735 608 610	38
735 608 611	38
735 608 612	38
735 608 613	38
735 608 614	38
735 640 105	49
735 640 106	49
735 640 107	49
735 640 108	49
735 640 109	49
735 640 110	49
735 640 111	49
735 648 606	38
735 648 607	38
735 648 608	38
735 648 609	38
735 648 610	38
735 648 611	38
735 648 612	38
735 648 613	38
735 648 614	38
735 690 405	39
735 690 406	39
735 690 407	39
735 690 408	39
735 690 409	39
735 690 410	39
735 690 411	39
735 690 422	39

Code	Page
735 690 423	39
735 690 424	39
735 730 106	150
735 730 107	150
735 730 108	150
735 730 109	150
735 730 110	150
735 730 111	150
735 740 106	85
735 740 107	85
735 740 108	85
735 740 109	85
735 740 110	85
735 740 111	85
735 790 206	45
735 790 207	45
735 790 208	45
735 790 209	45
735 790 210	45
735 790 211	45
735 790 257	46
735 790 258	46
735 790 259	46
735 790 260	46
735 798 565	36
735 798 590	112
735 798 596	112
735 798 597	112
735 798 598	112
735 798 806	35
735 798 807	35
735 798 808	35
735 798 809	35
735 798 810	35
735 798 811	35
735 798 812	35
735 798 813	35
735 798 814	35
735 798 816	35
735 798 817	35
735 798 819	35
735 798 820	35
735 798 831	111
735 798 832	111
735 798 833	111
735 798 834	111
735 798 835	111
735 798 836	111
735 798 837	111
735 798 838	111
735 798 839	111
735 798 841	111
735 798 842	111
735 798 844	111
735 798 845	111
735 798 857	36
735 798 858	36
735 798 859	36
735 798 860	36
735 798 861	36
735 798 863	36
735 798 864	36
735 798 866	36
735 798 867	36
735 798 869	36
735 798 870	36
735 798 882	112

Code Index

Code	Page
735 798 883	112
735 798 884	112
735 798 885	112
735 798 886	112
735 798 888	112
735 798 889	112
735 798 891	112
735 798 892	112
735 798 894	112
735 798 895	112
735 810 106	44
735 810 107	44
735 810 108	44
735 810 109	44
735 810 110	44
735 810 111	44
735 908 500	113
735 908 501	113
735 908 502	113
735 908 503	113
735 908 504	113
735 908 505	113
735 908 506	113
735 908 507	113
735 908 508	113
735 908 511	113
735 908 513	113
735 908 515	113
735 908 521	113
735 908 526	113
735 908 531	113
735 908 532	113
735 908 533	113
735 908 551	37
735 908 553	37
735 908 555	37
735 908 561	37
735 908 566	37
735 908 580	37
735 908 584	37
735 908 585	37
735 908 588	37
735 908 590	37
735 908 592	37
735 908 595	37
735 908 596	37
735 908 597	37
735 908 600	113
735 908 601	113
735 908 602	113
735 908 603	113
735 908 604	113
735 908 605	113
735 908 606	113
735 908 607	113
735 908 608	113
735 908 609	113
735 908 610	113
735 908 611	113
735 908 612	113
735 908 613	113
735 908 614	113
735 908 615	113
735 908 616	113
735 908 617	113
735 908 618	113
735 908 619	113

Code	Page
735 908 621	113
735 908 622	113
735 908 623	113
735 908 624	113
735 908 625	113
735 908 626	113
735 908 627	113
735 908 637	37
735 908 641	37
735 908 642	37
735 908 646	37
735 908 647	37
735 908 648	37
735 908 652	37
735 908 653	37
735 908 654	37
735 908 658	37
735 908 659	37
735 908 660	37
735 908 664	37
735 908 665	37
735 908 666	37
735 908 670	37
735 908 671	37
735 908 676	37
735 908 677	37
735 908 678	37
735 908 685	37
735 908 688	37
735 908 690	37
735 908 692	37
735 908 695	37
735 908 696	37
735 908 697	37
735 910 105	48
735 910 106	48
735 910 107	48
735 910 108	48
735 910 109	48
735 910 110	48
735 910 111	48
735 910 206	52
735 910 207	52
735 910 208	52
735 910 209	52
735 910 210	52
735 910 211	52
735 910 265	40
735 910 266	40
735 910 267	40
735 910 268	40
735 910 269	40
735 910 270	40
735 910 271	40
735 910 334	47
735 910 337	47
735 910 341	47
735 910 342	47
735 910 346	47
735 910 347	47
735 910 348	47
735 910 352	47
735 910 353	47
735 910 354	47
735 910 355	47
735 910 358	47
735 910 359	47

Code	Page
735 910 360	47
735 910 361	47
735 910 362	47
735 910 505	51
735 910 506	51
735 910 507	51
735 910 508	51
735 910 509	51
735 910 510	51
735 910 511	51
735 910 555	40
735 910 556	40
735 910 557	40
735 910 558	40
735 910 559	40
735 910 560	40
735 910 561	40
735 910 706	118
735 910 707	118
735 910 708	118
735 910 709	118
735 910 710	118
735 910 711	118
735 910 736	118
735 910 737	118
735 910 738	118
735 910 739	118
735 910 740	118
735 910 741	118
735 914 205	52
735 914 206	52
735 914 207	52
735 914 208	52
735 914 209	52
735 914 210	52
735 914 211	52
735 914 265	41
735 914 266	41
735 914 267	41
735 914 268	41
735 914 269	41
735 914 270	41
735 914 271	41
735 914 306	118
735 914 307	118
735 914 308	118
735 914 309	118
735 914 310	118
735 914 311	118
735 914 406	119
735 914 407	119
735 914 408	119
735 914 409	119
735 914 410	119
735 914 411	119
735 914 505	51
735 914 506	51
735 914 507	51
735 914 508	51
735 914 509	51
735 914 510	51
735 914 511	51
735 914 555	40
735 914 556	40
735 914 557	40
735 914 558	40
735 914 559	40

Code Index

Code	Page	Code	Page	Code	Page
735 914 560	40	735 991 652	116	748 440 306	152
735 914 561	40	735 991 653	116	748 440 307	152
735 918 565	116	735 991 654	116	748 440 308	152
735 918 566	116	735 991 655	116	748 440 309	152
735 918 567	116	735 991 656	116	748 440 310	152
735 918 569	116	735 991 657	116	748 440 311	152
735 918 570	116	735 991 658	116	748 440 312	152
735 918 611	115	735 991 659	116	748 440 313	152
735 918 612	115	735 991 661	116	748 440 314	152
735 918 613	115	735 991 662	116	748 440 315	152
735 918 614	115	735 991 663	116	748 440 316	152
735 918 615	115	748 400 004	152	748 440 317	152
735 918 616	115	748 400 005	152	748 440 318	152
735 918 617	115	748 400 006	152	748 440 319	152
735 918 619	115	748 400 007	152	748 440 320	152
735 918 620	115	748 400 008	152	748 441 101	153
735 918 656	114	748 400 009	152	748 441 102	153
735 918 657	114	748 400 010	152	748 441 103	153
735 918 658	114	748 400 011	152	748 441 104	153
735 918 659	114	748 400 012	152	748 441 105	153
735 918 660	114	748 400 013	152	748 441 106	153
735 918 661	114	748 410 000	151	748 441 107	153
735 918 662	114	748 410 001	151	748 441 108	153
735 918 663	114	748 410 002	151	748 441 109	153
735 918 664	114	748 410 003	151	748 441 110	153
735 918 811	115	748 410 004	151	748 441 111	153
735 918 812	115	748 410 005	151	748 441 112	153
735 918 813	115	748 410 006	58	748 441 114	153
735 918 814	115	748 410 007	58	748 441 115	153
735 938 737	114	748 410 008	58	748 441 116	153
735 938 741	114	748 410 009	58	748 441 117	153
735 938 742	114	748 410 010	58	749 400 005	152
735 938 746	114	748 410 011	58	749 400 006	152
735 938 747	114	748 410 012	151	749 400 007	152
735 938 748	114	748 410 013	151	749 400 008	152
735 938 752	114	748 410 014	151	749 400 009	152
735 938 753	114	748 410 015	151	749 400 010	152
735 938 758	114	748 410 016	151	749 400 011	152
735 938 759	114	748 410 017	151	749 400 012	152
735 938 760	114	748 410 018	151	749 400 013	152
735 960 105	48	748 410 019	151	749 400 112	139
735 960 106	48	748 410 022	151	749 400 114	139
735 960 107	48	748 410 163	151	749 400 117	139
735 960 108	48	748 410 173	151	749 400 119	139
735 960 109	48	748 410 174	151	749 400 121	139
735 960 110	48	748 410 182	151	749 400 123	139
735 960 111	48	748 413 001	153	749 400 125	139
735 960 405	52	748 413 002	153	749 401 315	154
735 960 406	52	748 413 003	153	749 401 316	154
735 960 407	52	748 413 007	153	749 401 317	154
735 960 408	52	748 413 012	153	749 401 318	154
735 960 409	52	748 413 013	153	749 401 319	154
735 960 410	52	748 413 014	153	749 401 320	154
735 960 411	52	748 413 015	153	749 401 321	154
735 968 606	41	748 413 016	153	749 401 322	154
735 968 607	41	748 413 017	153	749 401 323	154
735 968 608	41	748 413 018	153	749 401 324	154
735 968 609	41	748 413 019	153	749 401 325	154
735 968 610	41	748 413 022	153	749 401 326	154
735 968 611	41	748 413 163	153	749 401 327	154
735 968 731	119	748 413 173	153	749 410 000	151
735 968 732	119	748 413 182	153	749 410 001	151
735 968 733	119	748 440 101	152	749 410 002	151
735 968 734	119	748 440 302	152	749 410 003	151
735 968 735	119	748 440 303	152	749 410 004	151
735 968 736	119	748 440 304	152	749 410 005	39
735 991 651	116	748 440 305	152	749 410 006	39

Code Index

Code	Page
749 410 007	39
749 410 008	39
749 410 009	39
749 410 010	39
749 410 011	39
749 410 012	151
749 410 013	39
749 410 014	39
749 410 015	39
749 410 016	151
749 410 017	151
749 410 018	151
749 410 019	151
749 410 022	151
749 410 163	151
749 410 173	151
749 410 174	151
749 410 182	151
749 411 005	117
749 411 006	117
749 411 014	117
749 411 015	117
749 411 016	117
749 411 054	117
749 411 062	117
749 411 120	117
749 411 172	117
749 413 001	153
749 413 002	153
749 413 003	153
749 413 007	153
749 413 012	153
749 413 013	153
749 413 014	153
749 413 015	153
749 413 016	153
749 413 017	153
749 413 018	153
749 413 019	153
749 413 022	153
749 413 163	153
749 413 173	153
749 413 182	153
749 440 101	152
749 440 302	152
749 440 303	152
749 440 304	152
749 440 305	152
749 440 306	152
749 440 307	152
749 440 308	152
749 440 309	152
749 440 310	152
749 440 311	152
749 440 312	152
749 440 313	152
749 440 314	152
749 440 315	152
749 440 316	152
749 440 317	152
749 440 318	152
749 440 319	152
749 440 320	152
749 441 101	153
749 441 102	153
749 441 103	153
749 441 104	153

Code	Page
749 441 105	153
749 441 106	153
749 441 107	153
749 441 108	153
749 441 109	153
749 441 110	153
749 441 111	153
749 441 112	153
749 441 114	153
749 441 115	153
749 441 116	153
749 441 117	153
749 470 003	75
749 470 059	75
749 470 062	75
749 470 106	75
749 470 151	75
749 470 231	75
790 103 031	173
790 103 033	173
790 109 011	174
790 109 012	174
790 109 013	174
790 121 001	165
790 121 002	164
790 121 004	166
790 121 005	167
790 121 006	168
790 121 010	172
790 121 022	169
790 121 023	169
790 121 034	170
790 121 035	170
790 121 036	171
790 121 037	171
790 121 038	171
790 121 047	169
790 121 048	169
790 121 049	169
790 121 052	170
790 121 053	170
790 121 055	170
790 121 061	170
790 121 062	170
790 121 063	170
790 121 064	170
790 121 065	170
790 121 066	170
790 121 067	170
790 121 068	170
790 121 069	170
790 121 072	171
790 121 073	171
790 121 075	171
790 121 077	171
790 121 111	169
790 121 112	169
790 121 113	169
790 121 114	169
790 121 115	169
790 121 116	169
790 121 117	169
790 121 118	169
790 121 119	169
790 122 041	169
790 122 042	169
790 122 043	169

Code	Page
790 122 044	169
790 122 045	169
790 122 046	169
790 122 085	174
790 122 087	171
790 122 091	170
790 122 092	170
790 122 093	170
790 122 094	170
790 122 095	170
790 122 096	170
790 131 005	160
790 131 038	171
790 131 039	171
790 131 040	171
790 131 041	171
790 131 042	171
790 131 043	171
790 131 471	163
790 131 472	163
790 131 473	163
790 133 009	161
799 495 145	174
799 495 146	174
799 496 008	174
799 496 009	174

GEORGE FISCHER SALES LIMITED (“George Fischer”) CONDITIONS OF SALE (FOR GOODS AND SERVICES)

GEORGE FISCHER SALES LIMITED (“George Fischer”) CONDITIONS OF SALE (FOR GOODS AND SERVICES)

1 INTERPRETATION

- 1.1 In these conditions of sale the following words will (unless the context otherwise requires) have the following meanings: “Conditions” means the conditions set out below and overleaf. “Contract” means any contract between George Fischer and the Customer for the sale of any Works. “Customer” means the company, firm, body or person purchasing the Works. “Customer’s Property” means any dies, tools, patterns, drawings, specifications, designs, packagings and any other equipment, goods, materials, instructions or information supplied by or on behalf of the Customer to George Fischer in connection with the Works. “Goods” means any goods agreed in the Contract to be provided by George Fischer to the Customer (including but not limited to the whole or any part or parts of them, any raw materials, finished or semi-finished materials, machinery, parts, spares, commodities and any materials, articles and commodities supplied in connection with the Services). “Services” means any services agreed in the Contract to be provided by George Fischer to the Customer (including but not limited to the whole or any part or parts of them). “Works” means the Goods and/or the Services (as appropriate).
- 1.2 Any reference in these Conditions to any statute or statutory provision will (unless the context otherwise requires) be construed as a reference to that statute or statutory provision as may be amended, consolidated, modified, extended, re-enacted or replaced from time to time.
- 1.3 The headings in these Conditions are for reference only and will not affect the interpretation of these Conditions.
- 1.4 In these Conditions the words “unless otherwise agreed in writing” will mean unless otherwise agreed in writing and signed by a director or commercial manager of George Fischer.
- 1.5 George Fischer reserves the right at any time to correct any clerical, typographical or other similar errors made by its employees.

2 QUOTATIONS

- 2.1 Any quotation (whether written or oral) is given on the basis that no contract will come into existence otherwise than in accordance with the provisions of clauses REF_Ref488760478 \n 3.5 and REF_Ref488760491 \n 3.6.
- 2.2 Unless otherwise agreed in writing any quotation is valid only for a period of 45 days from its date of issue provided that George Fischer has not previously withdrawn it by written or oral notice to the Customer.
- 2.3 Any quotation is based on the instructions and information provided by the Customer and George Fischer reserves the right to amend the quotation at any time to cover any increase in price which may arise as a result of additional or incomplete instructions or information.

3 APPLICATION OF TERMS

- 3.1 (Subject to clause REF_Ref515266224 \n 3.4) these Conditions are the only conditions on which George Fischer is prepared to deal with the Customer and they will apply to all Contracts to the exclusion of any other terms and conditions including but not limited to those which the Customer purports to apply.
- 3.2 No terms or conditions endorsed upon, delivered with, referred to or stipulated or contained in any purchase order or other similar document delivered or sent by the Customer to George Fischer will form part of the Contract.
- 3.3 Any reference overleaf to the Customer’s purchase order or other similar document will not be deemed to imply that any terms or conditions endorsed upon, delivered with, referred to or stipulated or contained in such purchase order or other similar document will have effect to the exclusion or amendment of these Conditions.
- 3.4 Any variation to these Conditions and any representation about the Works will only be effective if it is agreed in writing, contains a specific reference to these Conditions and is signed by a director or commercial manager of both parties.
- 3.5 Each purchase order for Works issued by the Customer will be deemed to be an offer by the Customer to purchase Works subject to these Conditions.
- 3.6 No purchase order placed by the Customer will be deemed to be accepted by George Fischer until a written acknowledgement of order is issued by George Fischer or (if earlier) George Fischer commences the Works or supplies the Works to the Customer.
- 3.7 The Customer must ensure that the content of its order and any applicable specification are complete and accurate.
- 3.8 Unless otherwise agreed in writing all drawings, illustrations, descriptions, specifications, technical data, advertising and other similar information issued by George Fischer or contained in George Fischer’s catalogues, brochures, trade literature, price lists or other similar published materials are issued or published only for the purpose of giving an approximate idea of the Works described in them and will not form part of the Contract.
- 3.9 Any purchase order which has been accepted by George Fischer in accordance with clause REF_Ref488760478 \n 3.5 and REF_Ref488760491 \n 3.6 may only be amended, cancelled, postponed or varied by the Customer with the prior written consent of George Fischer and on terms that the Customer will indemnify George Fischer in full against all losses (including but not limited to loss of profit), costs, damages, charges and expenses incurred (directly or indirectly) by George Fischer as a result of such amendment, cancellation, postponement or variation.

4 DELIVERY

- 4.1 Any times specified or agreed by George Fischer for the delivery of the Works are given in good faith but are an estimate only. If no time is specified or agreed by George Fischer delivery will take place within a reasonable time. Unless otherwise agreed in writing time for the delivery of the Works will not be of the essence of the Contract.
- 4.2 George Fischer will use its reasonable endeavours to deliver the Works within the times set out in clause 4.1 but George Fischer will not be liable for the consequences of any delay or failure to deliver if the duration of the delay is not substantial or if the delay or failure is due to any circumstances beyond George Fischer’s reasonable control or of an unexpected or exceptional nature.
- 4.3 (Subject to the provisions of clause REF_Ref488825221 \n 4.4) delivery will be deemed to take place when the Works are delivered to the Customer at such place as the parties may agree except that delivery to a carrier for the purpose of transmission to the Customer will be deemed to be delivery to the Customer and sections 32(2) and (3) of the Sale of Goods Act 1979 will not apply.
- 4.4 If George Fischer agrees to permit the Customer to collect the Works from George Fischer’s place of business then delivery will be deemed to take place when George Fischer notifies the Customer that the Works are ready for collection and unless otherwise agreed in writing the Customer will collect the Works within 3 working days of the issue of such notice.
- 4.5 George Fischer will use its reasonable endeavours to ensure where necessary that the Works will be packed so as to be adequately protected against damage in normal conditions of transit of usual duration. George Fischer will make such arrangements for the carriage and insurance of the Works as it agrees with the Customer.
- 4.6 George Fischer may deliver the Works in instalments. Deliveries of further instalments may be withheld until the Works comprised in earlier instalments have been paid for in full. Default by George Fischer (howsoever caused) in respect of one or more instalments will not entitle the Customer to terminate the relevant Contract as a whole.
- 4.7 In the event of any delay in the delivery of any Goods and/or the performance of any Services which are attributable to the Customer’s acts or omissions then:
(a) delivery of the Goods and/or performance of the Services will be deemed to have taken place at the time at which but for such delay or delays such delivery or performance would have taken place and any extra costs incurred as a result of such delay or delays will be added to the Contract price and will be payable by the Customer; and
(b) George Fischer may sell such Goods 28 days after such delay and deduct any monies payable to George Fischer by the Customer from the sale proceeds and account to the Customer for any excess or charge the Customer for any shortfall.
- 4.8 Where the Works are to be supplied from stock such supply is subject to the availability of the stock at the date of delivery.
- 4.9 On delivery to the Customer all Works should be examined. (Subject to clause 8.2) George Fischer will not be liable for any shortages in or non-delivery of the Works (even if caused by George Fischer’s negligence) unless the same is notified in writing by the Customer to George Fischer (together with all relevant details) within 14 days of the actual or anticipated date of delivery (as appropriate). Subject to such notice being provided George Fischer will, if it is reasonably satisfied that any Works have not been delivered as a result of George Fischer’s fault (in its sole discretion) either arrange for delivery as soon as reasonably possible or give credit (at the pro rata Contract price) to the Customer for such Works. Any shortages in or non-delivery of part of the Works will not affect the Contract in respect of the other parts of the Works.
- 4.10 If George Fischer complies with clause REF_Ref519060038 \n 4.9 it will (subject to clause REF_Ref515268830 \n 8.2) have no further liability (in contract, tort (including but not limited to negligence) or otherwise) for such shortages or non-delivery.

- 4.11 Whilst George Fischer will use reasonable endeavours to supply the exact quantity of the Works ordered by the Customer, George Fischer may supply and the Customer will accept up to 10% more or less than the exact quantity ordered. A pro rata charge or allowance at the Contract price will be made to cover any such variation.
- 4.12 The Customer (at its own expense) will ensure that the place where delivery of the Goods or performance of the Services is to take place is adequate and appropriate for such delivery or performance and will provide such access, equipment, facilities, protection, manual labour and information as may be required to enable George Fischer to perform its obligations under the Contract.

5 RISK AND OWNERSHIP

- 5.1 Unless otherwise agreed in writing the Works are at the risk of the Customer from the time of delivery or deemed delivery to the Customer (as appropriate) and loading and off loading (as appropriate) will be at the Customer’s risk. Section 20(2) of the Sale of Goods Act 1979 will not apply.
- 5.2 (Notwithstanding that risk in the Works will pass to the Customer in accordance with the provisions of clause REF_Ref488762748 \n 5.1) ownership of the Works (both legal and equitable) will only pass to the Customer (other than when ownership is properly vested in some other person by the operation of any statute) when George Fischer has received in full (in cash or cleared funds) all monies due to it from the Customer:
(a) in respect of the Works; and
(b) all other sums which are or which become due to George Fischer from the Customer on any account.
- 5.3 Until ownership of the Works has passed to the Customer under clause REF_Ref488762831 \n 5.2, the Customer will:
(a) hold the Works on a fiduciary basis as George Fischer’s bailee;
(b) keep the Works free from any charge, lien or other encumbrance;
(c) store the Works (at no cost to George Fischer) separately from all other materials of the Customer or any third party in such a way that they remain readily identifiable as George Fischer’s property;
(d) not destroy, deface or obscure any identifying mark on the Works or their packaging;
(e) maintain the Works in a satisfactory condition, insured on George Fischer’s behalf for their full price against all risks to the reasonable satisfaction of George Fischer and on request produce such policy of insurance to George Fischer;
(f) hold all proceeds of the insurance referred to in clause 5.3 REF_Ref515267181 \n 3.4 (e) on trust for George Fischer and not mix it with any other money or pay the proceeds into any overdrawn bank account; and
(g) not attach the Works to any real property without George Fischer’s consent.
- 5.4 The Customer may resell, use or otherwise dispose of the Works before ownership has passed to it only if any such sale, use or disposition will be effected in the ordinary course of the Customer’s business and will be a sale, use or disposition of George Fischer’s property on the Customer’s own behalf and the Customer will deal as principal.
- 5.5 George Fischer may while the owner of the Works (and without prejudice to any other rights it may have under or by virtue of these Conditions) demand the immediate return of the Works at any time and the Customer will forthwith comply with such demand and bear the expenses for such return.
- 5.6 The Customer grants to George Fischer (or its successors in title for the Works) and their respective employees and agents an irrevocable licence to enter at any time any premises where the Works are or may be situated for the purpose of inspecting or removing any such Works the ownership in which has remained with George Fischer. George Fischer will be entitled to recover payment for the Works notwithstanding that ownership of any of the Works has not passed from George Fischer.
- 5.8 The Works will be deemed sold or used in the order delivered to the Customer.

6 PRICE AND PAYMENT

- 6.1 The price stated in the Contract is based on the cost to George Fischer of materials, fuel, power, transport, taxes, duties, services, labour and all other costs at the date of George Fischer’s quotation, acknowledgement of order or supply (whichever is earlier). If at the date of delivery or deemed delivery of the Works there has been any increase in all or any of such costs, the price payable for the Works may be increased by George Fischer accordingly.
- 6.2 Quotations given in a currency other than sterling are based on the rate of exchange at the time of quoting and (unless otherwise agreed in writing between the parties) the price may be subject to revision if any different rate of exchange is ruling at the date of invoice.
- 6.3 (Unless otherwise agreed) the price for the Works is exclusive of any value added tax (and any other tax or duty relating to the manufacture, transportation, sale or delivery of the Works) and any costs or charges in relation to export and/or import, packaging, loading, unloading, carriage and insurance. Such costs and expenses will be paid by the Customer in addition to the price for the Works at the same time that it is due to pay for the Works.
- 6.4 Where George Fischer agrees (in its discretion) to bring forward the date of delivery of the Works at the Customer’s request any overtime or other additional costs reasonably incurred by George Fischer shall be charged to the Customer in addition to the Contract price.
- 6.5 George Fischer may invoice the Customer for the Works at any time after the delivery of the Works or the delivery of any instalment (as appropriate). If any delivery is postponed at the request or by the default of the Customer then George Fischer may submit its invoice at any time after the Works are ready for delivery or would have been ready in the ordinary course but for the request or default on the part of the Customer.
- 6.6 Customers who have been granted by George Fischer (in its sole discretion) a credit account facility will pay the price within 30 days of the end of the month in which the Works are despatched. George Fischer may (in its sole discretion) amend the terms of or withdraw such credit account facility at any time without notice with immediate effect and on such withdrawal all amounts due or accruing to George Fischer under the Contract will become immediately payable despite any other provision of these Conditions.
- 6.7 Customers who have not been granted a credit account facility will pay the price 5 working days prior to delivery of the Works.
- 6.8 No payment will be deemed to have been received until George Fischer has received cleared funds.
- 6.9 Time for payment will be of the essence of the Contract and the Customer will indemnify George Fischer against all expenses and legal costs incurred by George Fischer in recovering overdue amounts.
- 6.10 All payments payable to George Fischer under the Contract will become due immediately on termination of this Contract despite any other provision of these Conditions.
- 6.11 The Customer will make all payments due under the Contract without any deduction whether by way of set-off, counterclaim, discount, abatement or otherwise unless the Customer has a valid court order requiring an amount equal to such deduction to be paid by George Fischer to the Customer.
- 6.12 If the Customer fails to pay George Fischer any sum due pursuant to the Contract the Customer will be liable to pay interest to George Fischer on such sum from the due date for payment at an annual rate of 4% above the base lending rate of HSBC Bank plc from time to time accruing on a daily basis until payment is made in full (whether before or after any judgement). In the alternative, George Fischer in its absolute discretion, reserves the right to claim interest and compensation payments under the Late Payment of Commercial Debts (Interest) Act 1998.
- 6.13 Without prejudice to the provisions of clause REF_Ref515268302 \n 6.12 if the Customer fails or George Fischer reasonably believes that the Customer will fail to pay for the Work when due George Fischer may demand payment of all outstanding balances whether due or not, treat the Contract as repudiated by the Customer or suspend any future performance of the Contract or any other contract with the Customer until all overdue sums have been paid.

7 QUALITY

- 7.1 George Fischer warrants (subject to the provisions of this clause REF_Ref515268367 \n 7) that:
(a) on delivery of the Goods and for a period of 12 months from the date of delivery, the Goods will:
(i) be of satisfactory quality, within the meaning of the Sale of Goods Act 1979 (as amended); and
(ii) be reasonably fit for any particular purpose for which the Works are commonly supplied or are being bought (if the Customer has made known that purpose to George Fischer in writing and George Fischer has confirmed in writing that it is reasonable for the Customer to rely on the skill and judgement of George Fischer);
(b) and the Services will be performed with reasonable skill and care by properly qualified and experienced persons.

The above Terms of Business effective from 19th July 2006

GEORGE FISCHER SALES LIMITED ("George Fischer")

CONDITIONS OF SALE (FOR GOODS AND SERVICES) (Continued)

- 7.2 George Fischer will not be liable for any breach of any of the warranties in clause REF_Ref515268792 \r \h 7.1 unless:
- (a) the Customer gives written notice of the defect to George Fischer within 28 days of the date when the Customer discovers or ought reasonably to have discovered the defect;
 - (b) if the defect is as a result of damage in transit the Customer gives written notice of the defect to the carrier in the manner and within the appropriate time limit as set out in the carrier's terms of business; and George Fischer is given a reasonable opportunity after receiving such notice to examine such Works and the Customer (if requested to do so by George Fischer) returns such Works to George Fischer's place of business (at the Customer's cost) for the examination to take place there.
- 7.3 George Fischer will not be liable for a breach of any of the warranties in clause 7.1 where and to the extent that:
- (a) the defect arises from the Customer's Property or as a result of the Customer's negligence;
 - (b) the defect arises as a result of fair wear and tear, misuse, wilful damage, or abnormal working conditions;
 - (c) the defect arises as a result of any parts, materials or equipment not manufactured or workmanship not performed by George Fischer;
 - (d) the Customer makes any further use of such Works after giving written notice of the defect;
 - (e) the defect arises because the Customer has failed to follow George Fischer's instructions (whether oral or in writing) as to the storage, assembly, installation, commissioning, use, processing, handling or maintenance of the Works or (if there are none) good trade practice;
 - (f) the defect arises as a result of any installation, testing or commissioning of the Works performed by the Customer or any third party; or
 - (g) the defect arises as a result of any alteration, servicing or repair of the Works not made by George Fischer and without the written consent of George Fischer.
- 7.4 (Subject to clauses REF_Ref80676410 \r \h 7.2 and REF_Ref80676434 \r \h 7.3) if any of the Works do not conform with any of the warranties set out in clause REF_Ref515268792 \r \h 7.1 George Fischer will at its option and cost repair or replace such Goods (or the defective part), re-perform such Services or refund the price of such Works at the pro rata Contract rate.
- 7.5 If George Fischer complies with clause REF_Ref515268814 \r \h 7.4 it will (subject to clause REF_Ref515268830 \r \h 8.2) have no further liability (in contract, tort (including but not limited to negligence) or otherwise) for breach of any of the warranties in clause REF_Ref515268792 \r \h 7.1 in respect of such Works.
- 7.6 Any Goods replaced by George Fischer in accordance with the provisions of clause REF_Ref515268814 \r \h 7.4 will belong to George Fischer and any repaired or replacement Goods will be guaranteed on these terms for the unexpired portion of the original 12 month warranty period.
- 8 LIMITATION OF LIABILITY**
- THE PRICES CHARGED FOR THE WORKS ARE BASED STRICTLY ON THE UNDERSTANDING OF ACCEPTANCE BY THE CUSTOMER OF THE PROVISIONS IN THE CONTRACT FOR THE LIMITATION OF GEORGE FISCHER'S LIABILITY. SHOULD THE CUSTOMER WISH GEORGE FISCHER TO ACCEPT ADDITIONAL LIABILITY THIS MAY BE DISCUSSED BETWEEN THE PARTIES AND THE PRICE MAY BE INCREASED ACCORDINGLY.
- 8.1 All warranties, conditions and other terms implied by statute or common law (except for the conditions implied by section 12 of the Sale of Goods Act 1979 and section 2 of the Supply of Goods and Services Act 1982) are, to the fullest extent permitted by law, excluded from the Contract.
- 8.2 Nothing in these Conditions excludes or limits the liability of George Fischer for fraudulent misrepresentation or for any death or personal injury caused by George Fischer's negligence or for any breach of the conditions implied by section 12 of the Sale of Goods Act 1979 and section 2 of the Supply of Goods and Services Act 1982.
- THE CUSTOMER'S ATTENTION IS IN PARTICULAR DRAWN TO THE PROVISIONS OF CLAUSES REF_Ref515268901 \r \h 8.3 AND REF_Ref515268903 \r \h 8.4
- 8.3 (Subject to clause REF_Ref515268930 \r \h 8.1 and REF_Ref515268830 \r \h 8.2) George Fischer will not be liable to the Customer in contract, tort (including but not limited to negligence), misrepresentation or otherwise for any:
- (a) economic loss of any kind (including but not limited to direct or indirect loss of profit, business, contracts, revenue or anticipated savings);
 - (b) damage to the Customer's reputation or goodwill;
 - (c) product recall costs; or
 - (d) any special, indirect or consequential loss or damage (even if George Fischer has been advised of such loss or damage) arising out of or in connection with the Contract.
- 8.4 (Subject to the provisions of clause REF_Ref515268830 \r \h 8.2 and REF_Ref515268901 \r \h 8.3) George Fischer's total liability in contract, tort (including but not limited to negligence), misrepresentation or otherwise arising out of or in connection with the Contract will be limited to the Contract price.
- 9 THE CUSTOMER'S PROPERTY**
- 9.1 While George Fischer will take reasonable care of the Customer's Property whilst it is in George Fischer's possession, control or custody the Customer's Property will (unless otherwise agreed in writing) remain at the Customer's risk and all replacements and alterations of and repairs to the Customer's Property will be the Customer's responsibility.
- 9.2 George Fischer will not be liable for any loss or damage to the Customer's Property unless such loss or damage arises as a direct result of George Fischer's negligence. Where George Fischer is liable under this clause REF_Ref515269116 \r \h 9.2 George Fischer's liability to the Customer will be limited to the actual cost of the replacement or repair of the loss or damage to the Customer's Property.
- 9.3 The Customer will ensure that the Customer's Property is in good condition and suitable for use by George Fischer in the performance of the Contract and while George Fischer will use reasonable endeavours to verify any relevant aspects of the Customer's Property no responsibility is accepted by George Fischer for its accuracy.
- 9.4 Any defect in the Works which is due in whole or in part to the Customer's Property will not entitle the Customer to terminate the Contract, reject the Works, make any deductions from the Contract price or claim damages in respect of such defect.
- 9.5 The Customer will keep George Fischer indemnified in full against all liability, loss, damage, injury, claim, action, demand, expense or proceeding awarded against or incurred by George Fischer as a result of or in connection with the use by George Fischer of the Customer's Property unless such liability, loss, damage, injury, claim, action, demand, expense or proceeding is the result of George Fischer's negligent acts or omissions.
- 10 TOLERANCES AND TESTS**
- 10.1 Unless otherwise agreed in writing gauges, weights, chemical composition and analysis, quantities and sizes will, so far as possible, be adhered to but reasonable excesses and deficiencies will be accepted by the Customer, who will not be entitled to reject any Works on the ground that they are not precisely as specified.
- 10.2 Unless otherwise agreed in writing, all tests, test pieces and inspections required by the Customer and agreed by George Fischer will be charged extra. All tests and inspections will take place under George Fischer's standard testing arrangements, and such tests will be final (except in the case of manifest error). All tests are subject to analytical tolerances.
- 10.3 The Customer may attend (at its own cost) all tests provided that it notifies George Fischer in writing of its intention to do so. The Customer will then be given not less than 5 working day's prior notice of the proposed date and time of any test and, if the Customer fails to attend, the test will proceed in its absence although it will be deemed to have been made in its presence.
- 11 OWNERSHIP OF TOOLING**
- 11.1 Where patterns, dies, tools, drawings and equipment are not supplied by the Customer, only those which are specially made by George Fischer and separately charged to the Customer in full, will, when paid for by the Customer, become the property of the Customer.
- 11.2 George Fischer reserves the right to destroy or otherwise dispose of patterns, dies, tools, drawings and equipment in its possession, control or custody (whether or not the property of the Customer) from which the Customer has not required any Works to be made for a period of 12 months or more.
- 12 PACKING CASES AND PACKING MATERIALS**
- 12.1 Unless otherwise agreed in writing packing cases and packing materials will not be charged extra but, where stated to be returnable, will be returned to George Fischer in good condition, within one month of receipt by the Customer. Where not returnable, the Customer will dispose of all packing in accordance with all regulations (whether statutory or otherwise) relating to the protection of the environment.
- 13 CONFIDENTIALITY**
- 13.1 The Customer will keep confidential all technical data, commercial information, know how, specifications, inventions, processes, initiatives and other information which is of a confidential nature and which has been disclosed to the Customer by George Fischer and/or any member of the George Fischer group and/or its agents and any other confidential information concerning the business of George Fischer and/or any member of the George Fischer group or its products which the Customer may obtain ("Confidential Information").
- 13.2 The Customer will restrict disclosure of the Confidential Information to such of its employees, agents or subcontractors as need to know the same and will ensure that such employees, agents or subcontractors are subject to equivalent obligations of confidentiality as bind the Customer.
- 13.3 The Customer will not without the prior written consent of George Fischer publish or disclose the Confidential Information to any third party or make any use of the Confidential Information except to the extent necessary to implement the Contract.
- 14 INTELLECTUAL PROPERTY**
- 14.1 The Customer will keep George Fischer indemnified in full against all liability, loss, damage, injury, claim, action, demand, expense or proceeding in respect of any infringement or alleged infringement of any patent, registered design, unregistered design, design copyright, trademark or other industrial or intellectual property rights resulting from any use by George Fischer of the Customer's Property or any compliance by George Fischer with the Customer's instructions, whether express or implied.
- 14.2 (Unless otherwise agreed in writing) ownership in all intellectual property rights subsisting in, resulting from or relating to the Works or any associated plans, descriptions, blue prints, designs, technical information, drawings, documents or specifications (except where these relate solely to the Customer's Property) will vest in or be assigned to George Fischer. If the Customer in any way acquires any such rights it will promptly inform George Fischer and take such steps as George Fischer may reasonably require to assign such rights or vest such title in George Fischer.
- 14.3 Nothing in these Conditions will be construed as any representation or warranty by George Fischer that the design, manufacture, use or sale of the Works is not an infringement of any third party intellectual property rights.
- 15 TERMINATION**
- 15.1 George Fischer may terminate the Contract (and all other contracts between George Fischer and the Customer) immediately if:
- (a) the Customer fails to pay the price on the due date;
 - (b) the Customer is in breach of any term of the Contract and has failed to remedy such breach within 28 days of receipt of written notice specifying the breach and requiring it to be remedied;
 - (c) there is a material change in the ownership or control of the Customer; or
 - (d) the Customer is wound up or becomes insolvent or has a receiver or administrative receiver appointed or suffers the appointment or the presentation of a petition for the appointment of an administration or any equivalent or analogous event occurs in any relevant jurisdiction.
- 15.2 The termination of the Contract (howsoever arising) will be without prejudice to any rights and remedies which may have accrued to either party.
- 15.3 Any Conditions which impliedly have effect after termination or expiry will continue to be enforceable notwithstanding termination or expiry.
- 16 EXPORT SALES**
- 16.1 Where the Works are supplied for export from the United Kingdom the provisions of this clause REF_Ref515269501 \r \h 16 will (subject to any special terms agreed in writing between the parties) apply despite any other provision of these Conditions.
- 16.2 The Uniform Laws on International Sales Act 1967 will not apply.
- 16.3 Unless otherwise agreed in writing the currency will be pounds sterling. The Customer will establish and maintain in favour of George Fischer an irrevocable and confirmed letter of credit in English with a UK clearing bank payable on drafts drawn at sight on presentation to the bank by George Fischer of a certified copy of George Fischer's invoice. All bank charges and other expenses in relation to the letter of credit will be borne by the Customer.
- 16.4 Unless otherwise agreed in writing Works will be sold C.I.F. (as defined in INCOTERMS 2000 Edition).
- 16.5 The Customer will be responsible for complying with and shall comply with any legislation or regulation governing the export of the Works:
- (a) from the United Kingdom; and/or
 - (b) (where the Works are sourced from a country other than the United Kingdom) from such country and the importation of the Works into the country of destination and for payment of any relevant duties or taxes whether payable by the Customer or George Fischer.
- 16.6 Unless otherwise agreed in writing packing cases and packing materials will be charged extra but, where stated to be returnable, will be credited in full on return to George Fischer's place of business (carriage paid) in good condition, within one month of receipt by the Customer. Where not returnable, the Customer will dispose of all packing in accordance with all regulations (whether statutory or otherwise) relating to the protection of the environment.
- 17 LIEN**
- George Fischer will have in respect of unpaid debts due to it from the Customer a general lien on all property of the Customer which is in George Fischer's possession for whatever reason and whether worked upon or not.
- 18 ASSIGNMENT AND SUBCONTRACTING**
- 18.1 The Customer will not without the prior written consent of George Fischer assign or transfer the Contract or any part of it to any other person. George Fischer may without the prior written consent of the Customer assign, transfer or subcontract the Contract or any part of it to any other person.
- 19 GENERAL**
- 19.1 Each right or remedy of George Fischer under these Conditions is without prejudice to any other right or remedy which George Fischer may have under these Conditions or otherwise.
- 19.2 Any notice or document shall be deemed served, if delivered by hand, at the time of delivery, if posted, 48 hours after posting and if sent by facsimile transmission, at the time of transmission. George Fischer may also send a notice or document by electronic communication in an e-mail address notified to George Fischer by the Customer. Such notice or document shall be deemed served if sent by e-mail transmission 48 hours after the time of transmission.
- 19.3 The illegality, invalidity or unenforceability of any provision of these Conditions will not affect the legality, validity or unenforceability of any other provisions of these Conditions.
- 19.4 Failure or delay by either party in exercising any right or remedy provided by the Contract or by law will not be construed as a waiver of such right or remedy or a waiver of any other right or remedy.
- 19.5 A person who is not a party to the Contract will have no right under the Contracts (Rights of Third Parties) Act 1999 to enforce any term of the Contract. This clause REF_Ref515269598 \r \h 19.5 does not affect any right or remedy of any person which exists or is available otherwise than pursuant to that Act.
- 19.6 The Customer agrees that it will have no remedy in respect of any untrue statement innocently or negligently made by or on behalf of George Fischer prior to the Contract upon which the Customer relied in entering into the Contract whether such statement was made orally or in writing unless the statement has been expressly agreed in writing by a director of George Fischer and/or the statement has been expressly incorporated in writing into the Contract.
- 19.7 George Fischer shall not be in breach of these Conditions or otherwise liable to the Customer by reason of any delay in performance or non-performance of any of its obligations due to any circumstances outside George Fischer's reasonable control.
- 19.8 The Contract will be governed by English law and the parties submit to the non-exclusive jurisdiction of the English courts.

GF Piping Systems > worldwide at home

Our sales companies and representatives ensure local customer support in over 100 countries.

www.georgfischer.co.uk

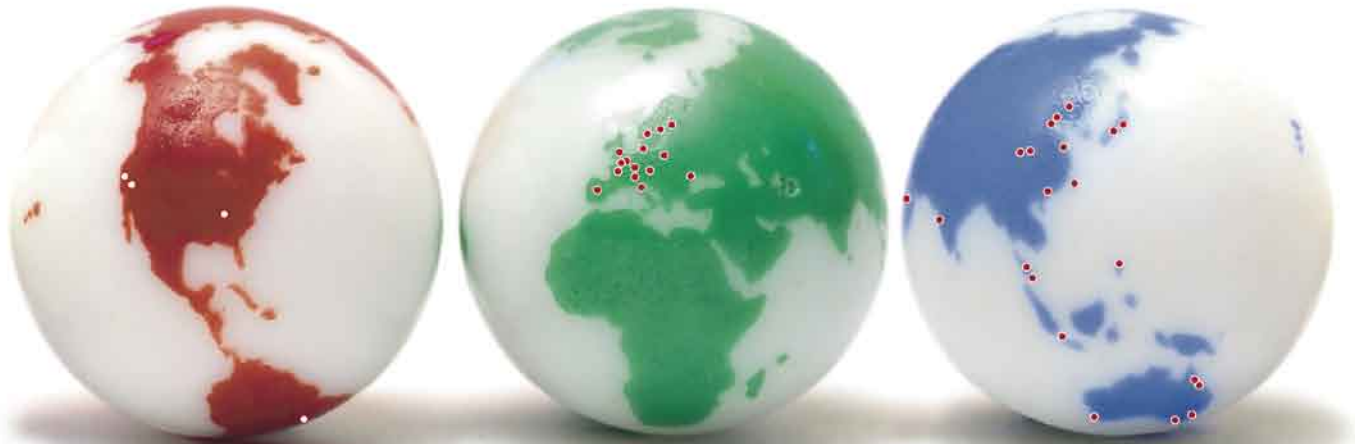

The technical data are not binding and not expressly warranted characteristics of the goods. They are subject to change. Please consult our General Conditions of Supply.

Australia

George Fischer Pty Ltd
Unit 1, 100 Belmore Road,
Riverwood, NSW 2210
Phone +61(0)2/95 54 39 77
australia.ps@georgfischer.com
www.georgfischer.com.au

Austria

George Fischer
Rohrleitungssysteme GmbH
3130 Herzogenburg
Phone +43(0)2782/856 43-0
austria.ps@georgfischer.com
www.georgfischer.at

Belgium/Luxembourg

George Fischer NV/SA
1070 Bruxelles/Brüssel
Phone +32(0)2/556 40 20
be.ps@georgfischer.com
www.georgfischer.be

Brazil

George Fischer Ltda
04795-100 S o Paulo
Phone +55(0)11/5687 1311
br.ps@georgfischer.com

China

George Fischer
Piping Systems Ltd Shanghai
Pudong, Shanghai 201319
Phone +86(0)21/58 13 33 33
china.ps@georgfischer.com
www.cn.piping.georgfischer.com

Denmark/Iceland

Georg Fischer A/S
2630 Taastrup
Phone +45 (0)70 22 19 75
info.dk.ps@georgfischer.com
www.georgfischer.dk

France

George Fischer S.A.S.
93208 Saint-Denis Cedex 1
Phone +33(0)1/492 21 34 1
fr.ps@georgfischer.com
www.georgfischer.fr

Germany

George Fischer GmbH
73095 Albershausen
Phone +49(0)7161/302-0
info.de.ps@georgfischer.com
www.vgd.georgfischer.de

George Fischer DEKA GmbH
35232 Dautphetal-Mornshausen
Phone +49(0)6468/915-0
deka.ps@georgfischer.com
www.dekapipe.de

India

George Fischer Piping Systems Ltd
400 093 Mumbai
Phone +91(0)22/2820 2362
in.ps@georgfischer.com

Italy

Georg Fischer S.p.A.
20063 Cernusco S/N (MI)
Phone +39(0)2/921 861
it.ps@georgfischer.com
www.georgfischer.it

Japan

Georg Fischer Ltd
556-0011 Osaka,
Phone +81(0)6/6635 2691
jp.ps@georgfischer.com
www.georgfischer.jp

Malaysia

Georg Fischer (M) Sdn. Bhd.
47500 Subang Jaya
Phone +60 (0)3-8024 7879
conne.kong@georgfischer.com.my

Middle East

George Fischer Piping Systems
Dubai, United Arab Emirates
Phone +971 4 289 41 20
gfdubai@emirates.net.ae
www.piping.georgfischer.com

Netherlands

Georg Fischer N.V.
8161 PA Epe
Phone +31(0)578/678 222
nl.ps@georgfischer.com
www.georgfischer.nl

Norway

Georg Fischer AS
1351 Rud
Phone +47(0)67 18 29 00
no.ps@georgfischer.com
www.georgfischer.no

Poland

Georg Fischer Sp. z o.o.
02-226 Warszawa
Phone +48(0)22/313 10 50
poland.ps@georgfischer.com
www.georgfischer.pl

Romania

Georg Fischer
Rohrleitungssysteme AG
70000 Bucharest - Sector 1
Phone +40(0)1/222 91 36
ro.ps@georgfischer.com

Singapore

George Fischer Pte Ltd
528 872 Singapore
Phone +65(0)67 47 06 11
sgp.ps@georgfischer.com
www.georgfischer.com.sg

Spain/Portugal

Georg Fischer S.A.
28046 Madrid
Phone +34(0)91/781 98 90
es.ps@georgfischer.com
www.georgfischer.es

Sweden/Finland

Georg Fischer AB
12523 Älvsjö-Stockholm
Phone +46(0)8/506 775 00
info.se.ps@georgfischer.com
www.georgfischer.se

Switzerland

Georg Fischer
Rohrleitungssysteme [Schweiz] AG
8201 Schaffhausen
Phone +41(0)52 631 30 26
ch.ps@georgfischer.com
www.piping.georgfischer.ch

Taiwan

Georg Fischer Ltd.
2F, No. 88, Hsing Te Road
San Chung City
Taipei Hsien, Taiwan (R.O.C.)
Phone +886 2 8512 2822
Fax +886 2 8512 2823

United Kingdom/Ireland

George Fischer Sales Limited
Coventry, CV2 2ST
Phone +44(0)2476 535 535
uk.ps@georgfischer.com
www.georgfischer.co.uk

USA/Canada/Latin America/Caribbean

George Fischer Inc.
Tustin, CA 92780-7258
Phone +1(714) 731 88 00
Toll Free 800/854 40 90
us.ps@georgfischer.com
www.us.piping.georgfischer.com

Export

Georg Fischer
Piping Systems [Switzerland] Ltd.
8201 Schaffhausen
Phone +41 (0)52-631 30 26
Fax +41 (0)52-631 28 93
export.ps@georgfischer.com